



EVOLVE

A New Era In Digital Welding



EVOLVE 200 Operator Manual



Your new product



Jasic.co.uk

Thank you for selecting this Jasic EVOLVE product.

This product manual has been designed to ensure that you get the most from your new Evolve product. Please ensure that you are fully conversant with the information provided paying particular attention to the safety precautions. The information will help protect yourself and others against the potential hazards that you may come across.

Please ensure that you carry out daily and periodic maintenance checks to ensure years of reliable and trouble free operation.

Please call your Jasic distributor in the unlikely event of a problem occurring.

Please record below the details from your product as these will be required for warranty purposes and to ensure you get the correct information should you require assistance or spare parts.

Date purchased _____

Seller Details _____

Serial number _____

(The serial number is normally located on the top or underside of the machine and will begin with AB)

For further details on your Jasic product warranty registration please visit: www.jasic-warranty.co.uk

Disclaimer

Whilst every effort has been made to ensure that the information contained within this manual is complete and accurate, no liability can be accepted for any errors or omissions.

Please Note:

- Products are subject to continual development and may be subject to change without notice.
- Depending on the machines software version number, screen layout or terminology may differ as to what's shown in this operating manual.
- Regularly check our product pages at www.jasic.co.uk for revision updated operating manuals.
- No part of this manual may be copied or reproduced by any means without the written permission of Wilkinson Star Limited.



CONTENTS

	Page
Your New Product	2
Index	3
Safety Instruction	4
Package and Contents	9
Product Overview	10
Technical Specifications	11
Description of Controls	12
Control Panel Description	14
Installation	15
Machine Control Settings:	
Screen Boot up sequence	17
WI-FI Connectivity	18
Control Panel Functions	19
Welding Modes	22
MMA:	
MMA Setup	23
Operating MMA	24
Guide to MMA Welding	31
MMA Welding Troubleshooting	35
TIG:	
TIG Setup	36
Operating TIG	37
TIG Quick Setup Guides	47
Guide to TIG welding	50
TIG Torch Description and Spare Parts List	55
TIG Welding Troubleshooting	56
MIG:	
MIG Setup	59
Operating MIG	60
Manual MIG	65
Synergic MIG	68
Pulse MIG	72
Double Pulse MIG	77
MIG Quick Setup Guides	82
MG Torch Trigger Control	86
Guide to MIG/MAG Welding	87
Spool Gun Operation	94
MIG Welding Chart	95
MIG Welding Troubleshooting	98
MIG Torch Description and Spare Parts List	100
Remote Control Details	101
MIG Torch Trigger Function (including remote control)	103
Remote Control Mobile App Connectivity	104
Maintenance & Troubleshooting	107
WEEE Disposal and RoHS Compliance Declaration	114
UKCA Declaration of Conformity	115
EC Declaration of Conformity	116
Statement of Warranty	117
Schematic	118
Synergic Program List	119
Options and Accessories	120
Notes	121
Jasic Contact Details	122

SAFETY INSTRUCTIONS



These general safety norms cover both arc welding machines and plasma cutting machines unless otherwise noted. The user is responsible for installing and operating the equipment in accordance with the enclosed instructions.

It is important that users of this equipment protect themselves and others from harm, or even death. The equipment must only be used for the purpose it was designed for. Using it in any other way could result in damage or injury and in breach of the safety rules.

Only suitably trained and competent persons should operate the equipment.

Pacemaker wearers should consult their doctor prior to using this equipment.

PPE and workplace safety equipment must be compatible for the application of the work involved.

Always carry out a risk assessment before carrying out any welding or cutting activity.

General electrical safety



Danger
Electric shock risk

The equipment should be installed by a qualified person and in accordance with current standards in operation.

It is the users responsibility to ensure that the equipment is connected to a suitable power supply. Consult your utility supplier if required.

Do not use the equipment with the covers removed. Do not touch live electrical parts or parts which are electrically charged. Turn off all equipment when not in use.

In the case of abnormal behaviour of the equipment, the equipment should be checked by a suitably qualified service engineer.

If earth bonding of the work piece is required, bond it directly with a separate cable with a current carrying capacity capable of carrying the maximum capacity of the machine current.

Cables (both primary supply and welding) should be regularly checked for damage and overheating.

Never use worn, damaged, under sized or poorly jointed cables.

Insulate yourself from work and earth using dry insulating mats or covers big enough to prevent any physical contact.

Never touch the electrode if you are in contact with the work piece return.

Do not wrap cables over your body.

Ensure that you take additional safety precautions when you are welding in electrically hazardous conditions such as damp environments, wearing wet clothing and metal structures.

Try to avoid welding in cramped or restricted positions.

Ensure that the equipment is well maintained. Repair or replace damaged or defective parts immediately.

Carry out any regular maintenance in accordance with the manufacturers instructions.

The EMC classification of this product is class A in accordance with electromagnetic compatibility standards CISPR 11 and IEC 60974-10 and therefore the product is designed to be used in industrial environments only.

WARNING: This class A equipment is not intended for use in residential locations where the electrical power is provided by a public low-voltage supply system. In those locations it may be difficult to ensure the electromagnetic compatibility due to conducted and radiated disturbances.

General operating safety



Never carry the equipment or suspend it by the carrying strap or handles during welding.

Never pull or lift the machine by the welding torch or other cables.

Always use the correct lift points or handles. Always use the transport under gear as recommended by the manufacturer.

Never lift a machine with the gas cylinder mounted on it.

If the operating environment is classified as dangerous, only use S-marked welding equipment with a safe idle voltage level. Such environments may be for example: humid, hot or restricted accessibility spaces.

SAFETY INSTRUCTION

⚠ CAUTION Use of Personal Protective Equipment (PPE)

PPE REQUIRED AT ALL TIMES Welding arc rays from all welding and cutting processes can produce intense, visible and invisible (ultraviolet and infrared) rays that can burn eyes and skin.

- Wear an approved welding helmet fitted with an appropriate shade of filter lens to protect your face and eyes when welding, cutting or watching.
- Wear approved safety glasses with side shields under your helmet.
- Never use any equipment that is damaged, broken or faulty.
- Always ensure there are adequate protective screens or barriers to protect others from flash, glare and sparks from the welding and cutting area.
- Ensure that there are adequate warnings that welding or cutting is taking place.
- Wear suitable protective flame resistant clothing, gloves and footwear.
- Ensure adequate extraction and ventilation is in place prior to welding and cutting to protect users and all workers nearby.
- Check and be sure the area is safe and clear of flammable material before carrying out any welding or cutting.



Some welding and cutting operations may produce noise. Wear safety ear protection to protect your hearing if the ambient noise level exceeds the local allowable limit (e.g: 85 dB).

Welding and Cutting Lens Shade Selector Guide

WELDING CURRENT	MMA ELECTRODES	MIG LIGHT ALLOY	MIG HEAVY METALS	MAG	TIG ALL METALS	PLASMA CUTTING	PLASMA WELDING	GOUGING ARC/AIR
10	8	10	10	10	9	11	10	10
15								
20								
30	9	10	10	10	10	11	11	10
40								
60	10	10	10	10	11	11	11	10
80								
100	11	11	11	11	12	12	13	11
125				12				
150				13				
175				14				
200	12	12	12	13	13	12	14	11
225								13
250		14						
275	13	13	13	14	14	13	14	12
300								13
350	13	14	13	14	14	13	14	13
400								14
450								14
500	14	15	14	15				15

SAFETY INSTRUCTION

Safety against fumes and welding gases



Warning
Fumes and
Gases

The HSE have identified welders as being an 'at risk' group for occupational diseases arising from exposure to dusts, gases, vapours and welding fumes. The main identified health effects are pneumonia, asthma, chronic obstructive pulmonary disease (COPD), lung and kidney cancer, metal fume fever (MFF) and lung function changes.

During welding and hot cutting 'hot work' operations, fumes are produced which are collectively known as welding fume. Depending upon the type of welding process being performed, the resultant fume generated is a complex and highly variable mixture of gases and particulates. Regardless of the length of welding being carried out, all welding fume, including mild steel welding requires suitable engineering controls to be in place which is usually Local Exhaust Ventilation (LEV) extraction to reduce the exposure to welding fume indoors and where LEV does not adequately control exposure it should also be enhanced by using suitable respiratory protective equipment (RPE) to assist with protecting against residual fume.

When welding outdoors appropriate RPE should be used.

Prior to undertaking any welding tasks an appropriate risk assessment should be carried out to ensure expected control measures are in place.



An example of personal fume protection

Locate the equipment in a well-ventilated position and keep your head out of the welding fume.

Do not breathe in the welding fume.

Ensure the welding zone is well-ventilated and provision should be made for suitable local fume extraction system to be in place.

If ventilation is poor, wear an approved air-fed welding helmet or respirator.

Read and understand the Material Safety Data Sheets (MSDS's) and the manufacturer's instructions for metals, consumable, coatings, cleaners and de-greasers.

Do not weld in locations near any de-greasing, cleaning or spraying operations.

Be aware that heat and rays of the arc can react with vapours to form highly toxic and irritating gases.

For further information please refer to the HSE website www.hse.gov.uk for related documentation.

Precautions against fire and explosion



Caution
Risk of fire

Avoid causing fires due to sparks and hot waste or molten metal.

Ensure that appropriate fire safety devices are available near the welding and cutting area.

Remove all flammable and combustible materials from the welding, cutting and surrounding areas.

Do not weld or cut fuel and lubricant containers, even if empty. These must be carefully

cleaned before they can be welded or cut.

Always allow the welded or cut material to cool before touching it or placing it in contact with combustible or flammable material.

Do not work in atmospheres with high concentrations of combustible fumes, flammable gases and dust.

Always check the work area half an hour after cutting to make sure that no fires have begun.

Take care to avoid accidental contact of the torch electrode to metal objects, as this could cause arcs, explosion, overheating or fire.

Know and understand your fire extinguishers

	Water	Foam spray	ABC powder	Carbon dioxide	Wet chemical
Symbol found on fire extinguishers at what they mean					
Wood, paper & textiles	✓	✓	✓	✗	✓
Flammable liquids	✗	✓	✓	✓	✗
Flammable gases	✗	✗	✓	✗	✗
Electrical contact	✗	✗	✓	✓	✗
Cooking oil & fats	✗	✗	✗	✗	✓

SAFETY INSTRUCTION

The working environment



Ensure the machine is mounted in a safe and stable position allowing for cooling air circulation.
Do not operate equipment in an environment outside the laid down operating parameters.
The welding power source is not suitable for use in rain or snow.

Always store the machine in a clean, dry space.

Ensure the equipment is kept clean from dust build up.

Always use the machine in an upright position.

Protection from moving parts



When the machine is in operation keep away from moving parts such as motors and fans.

Moving parts, such as the fan, may cut fingers and hands and snag garments.

Protections and coverings may be removed for maintenance and managed only by qualified personnel after first disconnecting the power supply cable.

Replace the coverings and protections and close all doors when the intervention is finished and before starting the equipment.

Take care to avoid getting fingers trapped when loading and feeding wire during set up and operation.

When feeding wire be careful to avoid pointing it at other people or towards your body.

Always ensure machine covers and protective devices are in operation.

Risks due to magnetic fields



The magnetic fields created by high currents may affect the operation of pacemakers or electronically controlled medical equipment.

Wearers of vital electronic equipment should consult their physician before beginning any arc welding, cutting, gouging or spot welding operations.

Do not go near welding equipment with any sensitive electronic equipment as the magnetic fields may cause damage.

Keep the torch cable and work return cable as close to each other as possible throughout their length.

This can help minimise your exposure to harmful magnetic fields.

Do not wrap the cables around the body.

Handling of compressed gas cylinders and regulators



Mishandling gas cylinders can lead to rupture and the release of high pressure gas.

Always check the gas cylinder is the correct type for the welding to be carried out.

Always store and use cylinders in an upright and secure position.

All cylinders and pressure regulators used in welding operations should be handled with care.

Never allow the electrode, electrode holder or any other electrically “hot” parts to touch a cylinder.

Keep your head and face away from the cylinder valve outlet when opening the cylinder valve.

Always secure the cylinder safely and never move with regulator and hoses connected.

Use a suitable trolley for moving cylinders.

Regularly check all connections and joints for leaks.

Full and empty cylinders should be stored separately.

Never deface or alter any cylinder

SAFETY INSTRUCTIONS

Fire awareness



The cutting and welding process can cause serious risks of fire or explosion. Cutting or welding sealed containers, tanks, drums or pipes can cause explosions. Sparks from the welding or cutting process can cause fires and burns. Check and risk assess the area is safe before doing any cutting or welding. Ventilate all flammable or explosive vapour from the workplace.

Remove any and all flammable materials away from the working area. If necessary, cover flammable materials or containers with approved covers (following manufacturers instructions) if unable to remove from the immediate area.

Do not cut or weld where the atmosphere may contain flammable dust, gas or liquid vapour. Always have the appropriate fire extinguisher nearby and know how to use it.

Hot parts



Always be aware that material being cut or welded will get very hot and hold that heat for a considerably long time which will cause severe burns if the appropriate PPE is not worn. Do not touch hot material or parts with bare hands.

Always allow for a cooling down period before working on material recently cut or welded. Use the appropriate insulated welding gloves and clothing to handle hot parts to prevent burns.

Noise awareness



The cutting and welding process can generate noise that can cause permanent damage to your hearing. Noise from cutting and welding equipment can damage hearing.

Always protect your ears from noise and wear approved and appropriate ear protection if noise levels are high.

Consult with your local specialist if you are unsure how to test for noise levels.

RF Declaration



Equipment that complies with directive 2014/30/EU concerning electromagnetic compatibility (EMC) and the technical requirements of EN60974-10 is designed for use in industrial buildings and not for domestic use where electricity is provided via the low voltage public distribution system.

Difficulties may arise in assuring class A electromagnetic compatibility for systems installed in domestic locations due to conducted and radiated emissions.

In the case of electromagnetic problems, it is the responsibility of the user to resolve the situation.

It may be necessary to shield the equipment and fit suitable filters on the mains supply.

LF Declaration



Consult the data plate on the equipment for the power supply requirements.

Due to the elevated absorbance of the primary current from the power supply network, high power systems affect the quality of power provided by the network. Consequently, connection restrictions or maximum impedance requirements permitted by the network at the public network connection point must be applied to these systems.

In this case, the installer or the user is responsible for ensuring the equipment can be connected, consulting the electricity provider if necessary.

SAFETY INSTRUCTION

Materials and their disposal



Welding equipment is manufactured with BSI published standards meeting CE requirements for materials which do not contain any toxic or poisonous materials dangerous to the operator. Do not dispose of the equipment with normal waste.



The European Directive 2012/19/EU on Waste Electrical and Electronic Equipment states that electrical equipment that has reached its end of life must be collected separately and returned to an environmentally compatible recycling facility for disposal.

For more detailed information please refer to the HSE website www.hse.gov.uk

EVOLVE 200 PACKAGE CONTENTS AND UNPACKING

Supplied within your new Jasic Evolve 200 product package will be the following items with each model. Use care when unpacking the contents and ensure all items are present and not damaged.

If damage is noted or items are missing, please contact the supplier in the first instance and before installing or using the product.

Record the product model, serial numbers and purchase date in the information section found on the inside front page of this operating manual.

Jasic Evolve 200 Package Contents:

Jasic Evolve 200 Power Source (JEV-200DP)

Depending on product purchased, the package may include a combination of the below:

- TIG Torch (TIG-110)
- MIG Torch (HC300-3E with 4 button control)
- Work Return Lead
- Gas Regulator
- Gas Hose
- Feed Rolls:
 - 1.0/1.2 'V' grooved (fitted)
 - 1.0/1.2 'U' grooved
- USB Stick with Operating Manual



Please Note:

Package contents may vary depending on country location and package part number purchased.

EVOLVE 200 PRODUCT OVERVIEW

This digital Evolve 200 inverter welding machine feature advanced technology that provides excellent welding performance along with user experience. The Evolve offers a stable arc that is ideal for MIG, DC TIG and MMA which can weld carbon steel, low alloy steel, stainless steel and other materials. Moreover, they offer many adjustable MIG, TIG and MMA functions and features that makes this Machine very durable and robust machines for a wide range of welding applications.

The unique electrical structure and air passage design inside the machine increases the dissipation of heat generated by power devices, thus improving the duty cycle of the machine.

Benefitting from the tunnel air passage, the equipment can effectively prevent damage to power devices and control circuits from dust drawn in by the fan, thus greatly improving the reliability of the equipment.

The 5" touch screen display offers the operator clear and informative data for the welding processed offered.



Features and functions that include:

- 3 welding processes: MIG Standard, MIG Synergic, MIG pulse , and MIG double pulse. TIG DC HF/Lift, TIG Synergic, TIG Pulse, TIG MIX and MMA.
- 100+ built-in synergic programs
- The Evolve 200 range offers a robust and industrial look with ergonomic design that includes tunnel cooling design.
- 5" LCD Touch Screen Display, Selecting weld parameters or changing your settings is easier with the large 5" touch screen display which offers is clear, easy to navigate interface.
- 230V mains input with auto compensation for mains voltage fluctuation also being generator friendly.
- MIG features that include 4 roll drive system, standard, pulse and Synergic MIG modes which allows for dialing in plate thickness, material, gas and wire size selection.
- Digital MIG torch option allows the operator to adjust amps or voltage from the torch handle.
- TIG features that include, synergic, pulse, mix, pre/post gas timers, down slope control and 2T/4T trigger modes plus many more.
- Digital TIG torch option allows the operator to adjust amps or voltage from the torch handle.
- Machine features such as, factory reset functions and voltage reduction device (VRD).
- Fan on-demand, circuitry that assists in prolonging the life span of the internal fan which reduces the accumulation of grinding dust inside the machine.
- Overcurrent and overheat protection.
- MMA features that include, arc force, hot start current and anti-stick that offer easy arc starting, low spatter, stable current which offers good weld bead shape making this machine ideal for a wide range of electrodes.
- Ability to save up to 100 welding programs with welding parameters automatically saved on machine shutdown which are restored automatically upon restarting the machine.
- A range of optional wired remote controls are available (via front panel mounted 12 pin socket).
- MIG spool gun compatible.
- High quality finish to product mouldings with Heavy duty 35-50mm dinse output sockets.

EVOLVE 200 TECHNICAL SPECIFICATIONS

Parameter	Unit	Jasic Evolve 200 (N2D2)
Rated input (U1)	AC Volts	230v +/- 15%
Rated input Frequency	Hz	50/60
Rated input current (Ieff)	A	MMA 15.5 MIG 15.8 TIG 11.9
Rated input current (Imax)	A	MMA 31 MIG 31.5 TIG 23.7
Rated input power	kVA (kW)	5.8 (3.8kW)
Rated maximum output	-	MMA 180A/27.2V MIG 200A/24V TIG 200A/18V
Welding current range	A	MMA 20 ~ 180 MIG 40 ~ 200 TIG 5 ~ 200
MIG voltage range (U2)	V	MIG 12 ~ 35
Rated duty cycle (X) rated at 40°C	%	25%
Wire Feed Type	-	4 Roll Drive
Wire feed speed range	m/min	0.8 ~ 18
Suitable wire size	mm	0.6 - 0.8 - 1.0 - 1.2 *
Suitable Spool size	-	200mm (5kg)
No load voltage (U0) VRD No load voltage (Ur) (MMA/TIG)	V	77V 14.3V (VRD)
Efficiency	%	81 ~ 86
Idle State Power	W	< 50
Power factor	cosφ	0.65
Characteristic	-	CC/CV
Standard	-	EN60974-1
Protection class	IP	IP23S
Insulation class	-	H
Pollution Level	-	Grade 3
Noise	Db	< 70
Operating Temperature range	°C	-10 ~ +40
Storage temperature	°C	-25 ~ +55
Size (with handle)	mm	605 x 400 x 230
Net weight	Kg	17
Overall weight	Kg	19

* Dependant on the material type selected.

Please Note

Due to variations in manufactured products all claimed performance ratings, capacities, measurements, dimensions and weights quoted are approximate only. Achievable performance and ratings when in use can depend upon correct installation, applications and use along with regular maintenance and service.

DESCRIPTION OF CONTROLS - JASIC EVOLVE 200

Front view Jasic Evolve 200+

1. 5" Digital touch screen (see page 14 For further information)
2. Back 'control' button
3. Left control dial and switch
4. Right control dial and switch
5. Menu control button
6. "+" Output terminal, The connection for the torch in MIG mode *
7. MIG torch outlet, The connection used to connect the euro style MIG torch
8. "-" Output terminal, The connection for the work return lead in MIG mode *
9. Wired remote control connection (12 pin socket)
10. TIG torch switch connection (2 pin socket)
11. TIG torch Shielding gas outlet connection, (quick connect/release fitting type)

* Panel socket size is 35/50mm

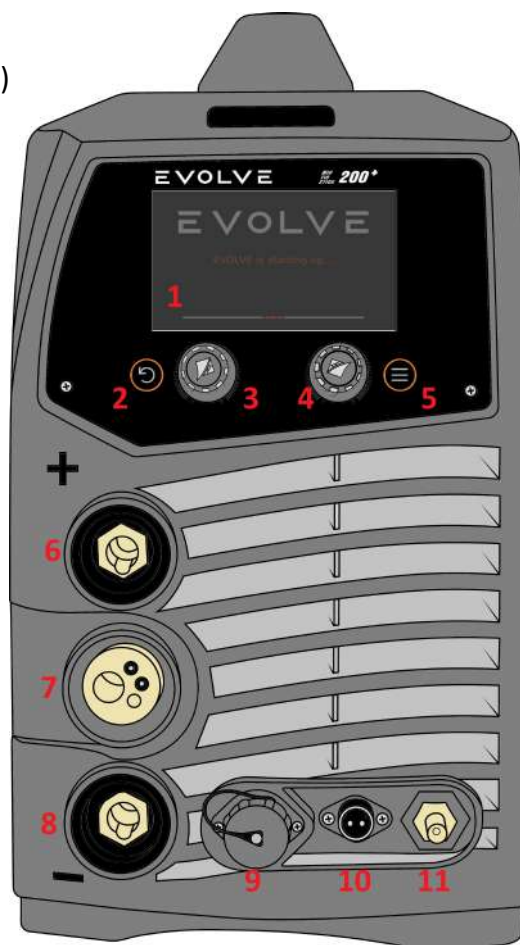

Rear view Jasic Evolve 200+

12. ON/OFF power switch
13. Shielding gas inlet (quick connect/release fitting type)
14. Input power cable
15. Cooling air vents
16. Machines technical specification plate
17. Carry handle



DESCRIPTION OF CONTROLS - JASIC EVOLVE 200

Side view Jasic Evolve 200+

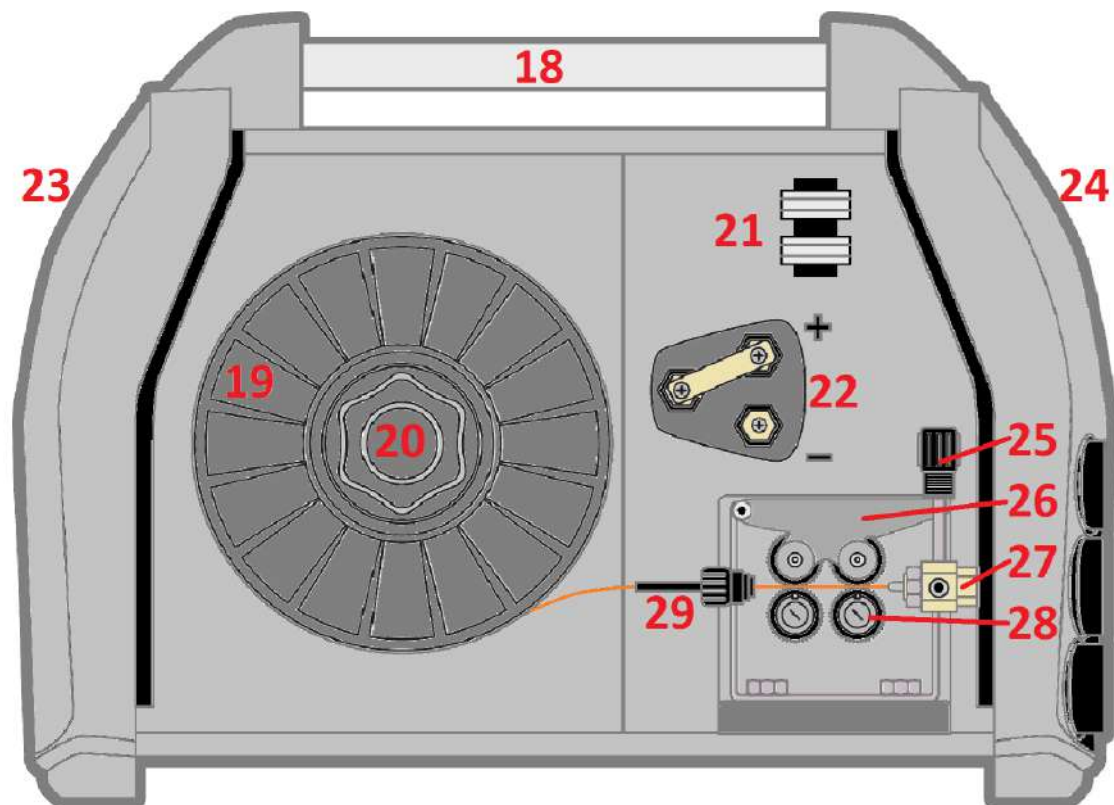

18. Carry Handle.
19. 5Kg (200mm dia) reel of wire.
20. Wire spool holder and tensioner: Allows a 5Kg (200mm dia) reel of wire to be located in place via an alignment pin and then locked in place with the locking nut. The spool holder also has a brake arrangement to ensure correct tension of the wire, this is done by turning the central bolt with an Allen key clockwise (to tighten) or anti clockwise (to loosen).
21. Accessory Holder: Allows for storage of additional feed drive rolls.
22. Adjustment point to change the euro MIG torch outlet polarity to be either positive '+' or negative '-'. When using gas set the connection to '+' when using 'gasless' welding wire set the connection to '-'.
23. Rear panel (see page 12 for further details).
24. Front panel (see page 12 for further details).
25. The drive roll tensioner arrangement that allows the operator to place the correct amount of tension to the top roller assembly.
26. Upper pressure roll assembly: Holds the upper drive roll in place which applies pressure to the welding wire via the fitted grooved drive roll, the pressure is applied via the drive roll tensioner which allows the correct amount of tension to be applied to the top roller to ensure good feed of the wire through the MIG torch.
27. Outlet feed adaptor: Part of the euro outlet connector assembly which contains the inner outlet guide which ensures smooth wire feed from the drive assembly through to the MIG torch.
28. Wire feed rollers and retaining nuts. Secures and holds the grooved drive rolls in place. The feed rolls supplied and fitted with the machine is the 0.8mm/1.0mm V (see page 9 for further details).
29. Inlet wire guide: The welding wire is fed through the inlet guide prior to feeding through the drive rollers.

DESCRIPTION OF CONTROL PANEL - JASIC EVOLVE 200



Front control panel Jasic Evolve 200

The digital users control screen is a 5" touch screen which can easily be used to navigate the various welding process menus and parameters to select and adjust said values.

1. In the top right display, icons located here will inform the operator the functional state of Wi-Fi, JTE Cloud, Bluetooth connections and if any new firmware is available.
2. This top bar section line displays the welding process the machine is currently in and the various adjustable welding parameters. These commands can be controlled either by the touch screen or by the control knobs.
3. This area of the screen will display your chosen welding settings and during welding will display the real time actual output current and voltage. At the end of the welding process, this area will display and hold the late welding values of the output current and voltage until one of the control panel dials of the screen is touched or adjusted..
4. In the bottom display area will be shown the welding process data and this data will be different depending on which welding process is chosen.
5. Back or return button, Pressing this button will return you to the previous page. This button can also be pressed to exit a pop up menu. See page 19 for further details.
6. The left control dial will adjust various parameters such as amps, wire feed speed and scrolling. See page 19 for further details.
7. The right control dial will adjust various parameters depending on welding mode selected. See page 19 for further details.
8. Menu button, Pressing this button will take you to the machine settings menu. See page 19 for further details.

INSTALLATION

Installation

The owner/user are responsible for installing and using this welding machine according to this operating manual.

Before installing this equipment, the owner/user shall make an assessment of potential hazards in the surrounding area.

Unpacking

Check the packaging for any signs of damage. Contact your supplier in the first instance if any item is missing or damaged. Carefully remove the machine and retain the packaging or at least until the installation is complete.

Lifting

The Jasic Evolve 200 has an integrated handle for easy hand lifting only. Always ensure the machine is lifted and transported safely and securely.



Location

The machine should be located in a suitable position and environment.

Care should be taken to avoid moisture, dust, steam, oil or corrosive gases.

Place on a secure level surface and ensure that there is adequate clearance around the machine to ensure natural airflow. Do not use the system in rain or snow.

Position the welding power supply near an appropriate power point ensuring you leave at least 30cm of space around the machine to allow for proper ventilation.

Always place the machine on a firm level surface before using, ensuring it cannot tip over. Never use the machine on its side.

Most metals including stainless steel can give off toxic fume when welded or cut.

To protect the operator and others working in the area its important to have adequate ventilation in the work area to ensure air quality level meets all local and national standards.

Warning!



The following operation requires sufficient professional knowledge on electric aspects and comprehensive safety knowledge. All connections shall be made with the power supply turned off. Incorrect input voltage may damage the equipment.

Electric shock may cause death; after switching off the machine, there are still high voltages within the machine, so if removing the covers do not touch any of the live parts on the equipment for at least 10 minutes. Never connect the machine to the mains supply with the panels removed.

The electrical connection of this equipment shall be carried out by suitably qualified personnel and these shall be made with the power supply off. Incorrect voltage may damage the equipment.

Input power connection

Before connecting the machine you should ensure that the correct supply is available.

Details of the machine requirements can be found on the data plate of the machine or in the technical specification table shown on page 11 within this manual.

This equipment should always be connected by a qualified competent person.

Always ensure the equipment is correctly grounded.

INSTALLATION

Input Power Connection continued

1. Test with multi-meter to ensure the input voltage value is within the specified input voltage range.
2. Ensure that the power switch of the welder is turned off.
3. Wire the input mains cable wires to the correct sized mains plug, ensuring that the live, neutral and earth (ground) wires are connected correctly.
4. Carry out an approved electrical test of the machine if required.
5. Ensure that the input fuse is correctly rated for the machine.
6. Connect the machine mains power plug firmly to the corresponding supply socket.

Please Note!



If the machine needs to be operated on long extension leads, then please use an extension lead where the cable has a larger cross-sectional area to reduce the voltage drop. Please consult your electrician or electrical supplier for the recommended size.

Gas Connections

The gas regulator is designed to reduce and control the high pressure gas from a cylinder or pipeline to the working pressure required for the Jasic TIG machine.

Before fitting the regulator, clean the cylinder valve outlet and match the regulator to cylinder and before connecting, ensure the regulator and the regulator inlet and cylinder outlet match. Connect the regulator inlet connection to cylinder and tighten it firmly (do not overtighten) with a suitable spanner. If using a flowmeter, connect to the regulator outlet. Connect the gas hose to the regulator or flowmeter which is now located on the shield gas cylinder and connect the other end to the Jasic machine.

With the regulator connected to cylinder, always stand to one side of regulator and only then slowly open the cylinder valve.

Slowly turn adjusting knob in (clockwise) direction until the outlet gauge indicates that you have set the required flow rate.

To reduce flow rate, turn the adjusting screw anti-clockwise, until the required flow rate is indicated on the gauge/flow meter.



Output Power Connections

When inserting the cable plug of the work return lead, MMA electrode holder or TIG torch adapter into the dinse socket on the front panel of the welding machine, rotate it clockwise to tighten.

It is very important to check these power connections daily to ensure they have not become loose otherwise arcing may occur when used under load.

Wired hand-held remote-control connection

As standard the Evolve 200 machines are fitted with a 12 pin remote control socket (1). This allows for a matching 12 pin plug (2) of a hand held remote control (example shown right) or a foot pedal to be connected directly to the machine to offer the user remote operation control.

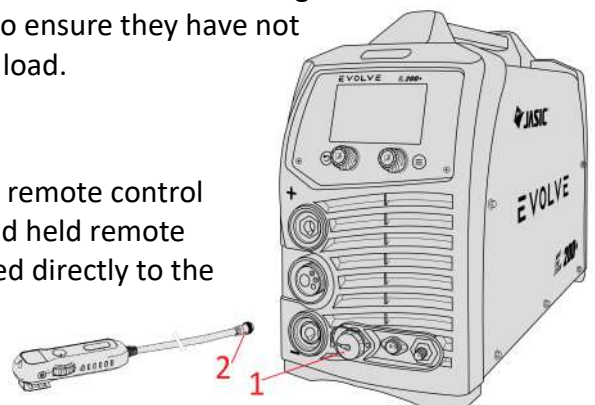

MACHINE POWER UP - MACHINE CONTROL SETTING

Boot Up Sequence

Upon switching the machine ON, the control panel has a boot up time of about 20 seconds, following the boot time the display shown will be the previous welding mode setup the last time the machine was used.

During boot up, the cooling fan is activated for a short period of time in order to load up the power supply of the inverter and allow the initial self-test.

The initial self-test allows the diagnostic system to check the inverter, the wire feeder motor driver, the auxiliary power supply for the machine and check on the mains cabling of the machine.



If any errors are noted during the self-test, the corresponding error code will be shown in the display with a short description of the error. The error chart on page 108 lists all error codes.

During the initial self-test, if any 'fatal' errors are encountered then an alarm will also be heard which will not allow the machine to continue and again the screen will display the noted error code and description.

Machine Settings

Once the machine has fully powered up, pressing the  MENU button with either the lower right button or the on screen icon, you will enter the main menu screen as shown below.

Please Note: Depending on the machine software version number, the order or terminology may differ.

The following options are available in the menu.

1. Wi-Fi Settings, where you can select or change your Wi-Fi network choices. On pressing this option the machine will instantly look for available networks, then you can select your chosen Wi-Fi network and then follow the prompts to connect to your network. If required, you will need to enter the Wi-Fi network password. The display screen will then show a touch screen keyboard which will allow you to input the password as required.

See the following pages for further information.

2. The QR Code enables fast identification of your machine, pressing this option will display the unique machine QR code. The QR code also enables quick linkup with the mobile app.
3. Select Language, allows the operator to choose from a selection of languages other than English from this menu. Selecting this option will display the available languages.
4. Machine Information, from here you can view your machine identification information, including: Serial Number, Machine Model, Firmware Version and Variant. See the following pages for further information.
5. Plug and Play accessories, this option allows the operator to enable and disable additional torch modules, Selecting this option will display the available connected devices.
6. Software update, this option will check and update any available Firmware and variant Firmware.
 - Selecting this option will check for the latest updates (the machine needs to be connected to a Wi-Fi network to receive updates).
 - If a new update is available, select Update to initiate a firmware update.
 - If you are experiencing issues after updating firmware, select Recovery Firmware to restore the firmware to an earlier version.

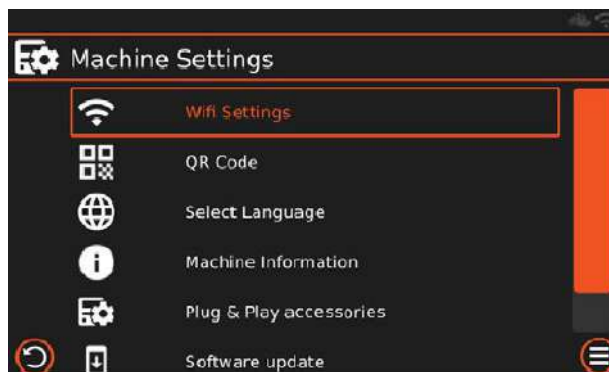

For further information on how to connect the machine to your Wi-Fi, see page 18.

MACHINE CONTROL SETTING

Wi-Fi Connectivity

 The Jasic Evolve 200 can be connected to your Wi-Fi network which offers additional features. Features include, software/firmware upgrades, remote controlling welding functions of the machine via the JTE Cloud mobile phone app.

Connecting the Wi-Fi is done via the Wi-Fi settings tab and by either rotating and pressing the left hand control dial or pressing the relevant Wi-Fi tab feature via the torch screen.

The screen will then display nearby Wi-Fi networks that are available along with the signal strength icon. Pressing on the required Wi-Fi name, a pop ups screen will show where you can enter the required password, when accessing the connection password the screen will then show a keyboard to allow you to enter the network password as shown below.

The JTE Cloud app is available in the App store for IOS, and in the Google play for Android. Open the JTE cloud app and follow the setup instruction in the app to connect the machine via Bluetooth to you phone for full remote control options via your mobile screen. See page 104 for further information.

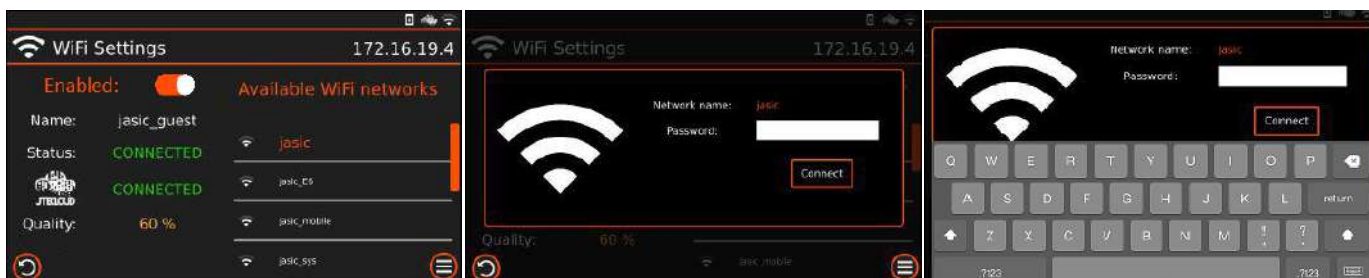

Machine Information Display Screen

When entering on the machine information tab you will enter and be shown various data in the “Machine information” screen:

- Serial number of the machine.
- Product model name.
- Firmware version of the machine.
- HMI version, it is the control panel firmware.

Press the return button to return to your welding screen.



Machine software upgrade descriptions *

In the menu “check for software update” you can check if new firmware is available for the machine by the screen box options “check” as shown right.

If a firmware update is available from the JTE cloud, a message is shown on the display “A new firmware is available”. To install, confirm by pressing the install button. During the download of the new software do not turn off the machine.

Once the download and install is complete, the machine and front panel will be reset automatically and once the reboot has finished the machine will be ready to use.

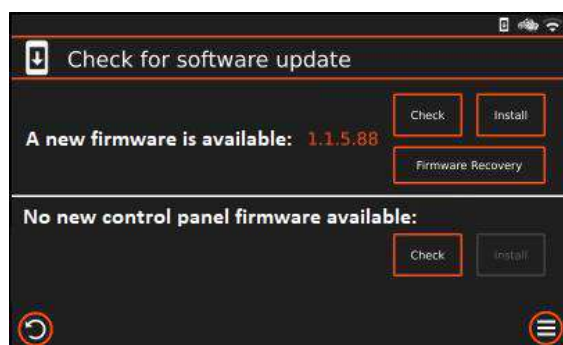

* Software updates are only available if the machine is connected to a Wi-Fi network connection.

DESCRIPTION OF 'LCD' CONTROL PANEL

Display screen

The display screen offers the operator a wealth of information including operation modes, a vast array of MIG, TIG DC and MMA parameters. The example screen is shown right and using the adjustment dials or touching the screen allows you to navigate through the machines options and the following pages will explain in greater details these features.



Parameter adjustment knobs

Rotating the control dials A or B clockwise or anti-clockwise allows the operator to scroll through the functions of the machine, increases or decreases parameter values including welding current and when these parameters are adjusted the values are shown in the display screen. Pressing the dials will also allow access to further information or settings.



- A. The left control dial will adjust various parameters such as amps, wire feed speed and scrolling.
- Rotating this control dial for digital screen navigation and cycling through menu options.
 - Press this control dial to confirm selected actions for weld screen options & menu parameters.
 - In MMA/TIG welding mode this control dial can be used to adjust current.
 - In MIG Manual welding mode this control dial will adjust wire speed.
 - In MIG Synergic and Pulse welding mode this control dial will adjust material thickness.
- B. The right control dial will adjust various parameters depending on welding mode selected.
- In TIG mode this knob can be used to adjust weld cycle parameters.
 - In MIG Manual mode this knob is used to adjust voltage.
 - In MIG Synergic / Pulse mode this can be used to adjust arc length.
 - In MMA mode this knob can be used to adjust Arc Force.

Return Button

The return button will take you back to the previous screen and the 'upper' level of the function you were within. This button when pressed will exit you from a pop up menu.



Menu Button

Pressing the menu button at any time will take you directly to the machine settings which will show on screen a number of options including: Wi-Fi settings, Language options, Connecting accessories and software updates.



Screen Icon - Top Right Corner



The Wi-Fi icon, if the machine is not connected to your Wi-Fi this icon will be greyed out, when connected to your local Wi-Fi network the icon will be white.



When wi-fi is connected the machine will automatically connect the JTE Cloud, when not connected the icon is greyed out, when connected to your wi-fi the icon will be white.



If you have installed the JTE app on your mobile phone and connect the app to the machine, it will connect via Bluetooth. When the app is not connected the Bluetooth icon is greyed out, if the machine is connected to your phone the icon will be white.



This icon will appear if there is a firmware download is available or that the machine is in the process of downloading updated firmware. This feature will only function if the machine is connected to your local wi-fi.

DESCRIPTION OF 'LCD' CONTROL PANEL

Memory function

Saving, recalling and resetting welding jobs

The Evolve 200 is capable of storing 100 TIG and MIG welding Jobs in it's memory and the jobs menu can be accessed from pressing the job menu icon as shown circled red in the image right in either MIG or TIG mode. If a Job is selected, the reference number of the Job is showing in the icon display. If 'Free Job' is shown, this indicate that no job is selected.

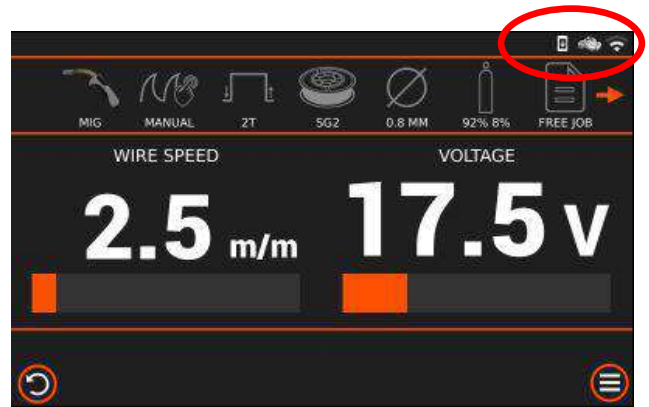

Welding Job Options

In the Job menu as shown right you can as follows:

- Load (an existing) job
- Save current settings as a Job
- Reset job to original values
- Return to free job

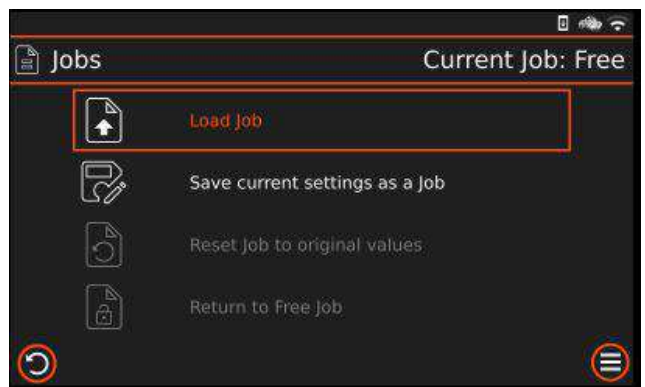

Save Current Settings as a Job

Select Save Current Settings as a Job to save your current settings.

Enter the job number from an available slot, then add an optional description for the job.

You can also overwrite an existing job by selecting the Save Current Settings as a Job option while a current job has been loaded and settings have been altered. Select the Overwrite Current Job option to confirm.

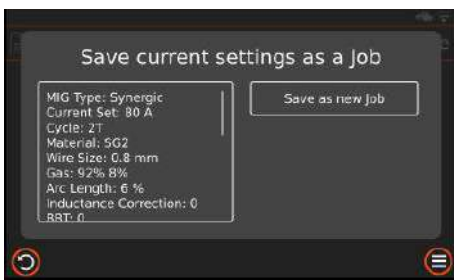

You can also overwrite a previously saved job using the 'Overwrite Current Job' command as shown right.

Press the 'yes' option within the pop up to overwrite the current job with the new set of welding data.

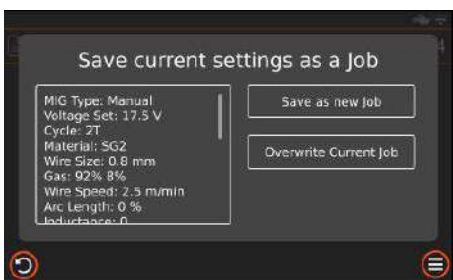

DESCRIPTION OF 'LCD' CONTROL PANEL

Memory function: (continued)

Load Job

Select Load Job to open up the list of saved jobs. These jobs can be filtered by material, wire diameter, gas type or your inputted description. Simply select and confirm the desired job to load the settings.

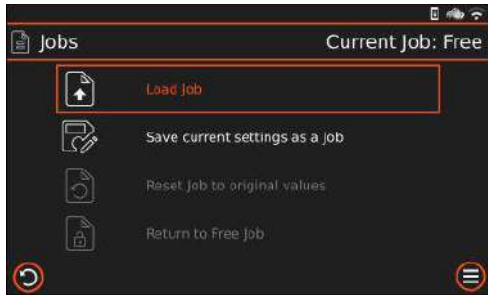

Reset Job to Original Values

If you have changed settings of a job and wish to reset the settings back to the original saved values, simply select the Reset Job to original values option.

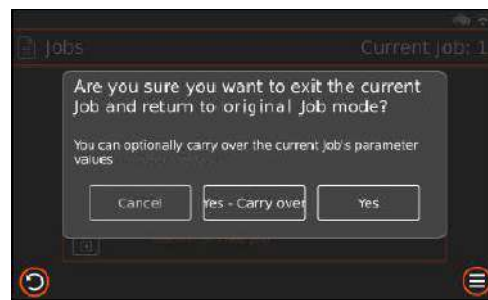

Return to Free Job

If you wish to exit the saved jobs and return to free settings, simply hit the Return to Free Job option. You will get the choice to carry over your saved settings into Free Job mode, or set the machine settings back to default.

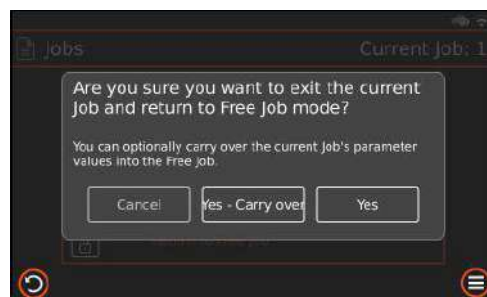

Job Maker

Saved welding job can also be defined within JTE APP and the JTE Cloud system.

- Job Maker
It is possible to define a free Job description and define the job protection level.
- Job Description
It is possible add a short description of the Job, the Job description will be shown in the Job data.



EVOLVE 200 MACHINE WELDING MODES

Welding modes available

The Jasic Evolve 200 welding modes are as follows:

- **MMA mode (DC Only)**
(Manual and Synergic function is also available)
- **TIG HF mode (DC Only)**
 - ⇒ Standard
 - ⇒ Pulse
 - ⇒ Mix
 - (Manual or Synergic function is also available in each TIG mode)
- **MIG mode (DC Only)**
 - ⇒ Manual
 - ⇒ Synergic
 - ⇒ Pulse
 - ⇒ Double pulse

Once the machine is powered up and the boot up sequence is complete, you will be able to select the required welding mode via the top left menu icon of either MMA, TIG or MIG.

To access these options, you can either rotate the left hand control dial and confirm by pressing the same control dial OR by pressing the touch screen and sliding your finger to select the required choice.

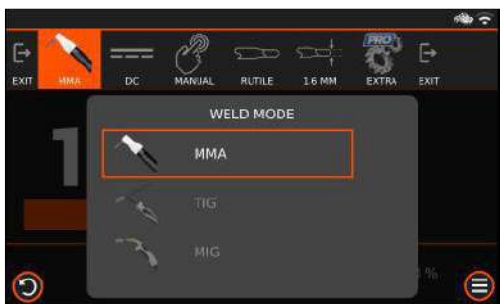

For MMA, select the weld mode icon by either rotating and pressing the left control dial or touching the weld mode icon to confirm the required selected welding mode.

For MMA setup instructions, please go to page 23.

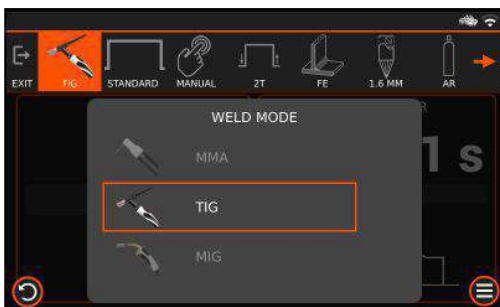

For TIG, select the weld mode icon by either rotating and pressing the left control dial or touching the weld mode icon to confirm the required selected welding mode.

For TIG setup instructions, please go to page 36.

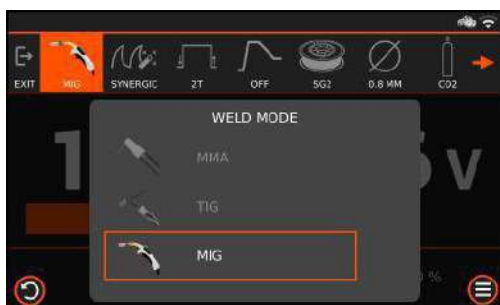

For MIG, select the weld mode icon by either rotating and pressing the left control dial or touching the weld mode icon to confirm the required selected welding mode.

For MIG setup instructions, please go to page 59.

An alternative to using the screen to change welding mode is for example, if the machine is set in MMA mode and the operator wants to weld in MIG, it is sufficient enough (if the MIG torch is connected) that pressing the MIG torch trigger will automatically place you into MIG welding mode without requiring the operator to access the control screen, you will also be returned to the last MIG settings used. The same thing will happen if pressing a TIG torch switch, (if the TIG torch is connected).

To access MMA, from either MIG or TIG mode, you must use the control screen.

MMA SETUP

Output connections

Electrode polarity is generally determined by the type of welding rod being used although in general when using manual arc welding electrodes the electrode holder is connected to the positive terminal and the work return to the negative terminal.

Generally, there are two connection methods of DC welder: DCEN and DCEP connection.

DCEN: The welding electrode holder is connected to the negative polarity, and the workpiece is connected to the positive polarity.

DCEP: The electrode holder is connected to the positive polarity, and the workpiece is connected to the negative polarity.

The operator can choose DCEN based on the base metal and welding electrode.

Generally speaking, DCEP (DC+ electrode) is recommended for basic electrodes (electrode connected to the positive polarity, as shown right).

Always consult the electrode manufacturer's data sheet if you have any doubts on machine setup.



MMA welding

1. When connecting welding cables, always ensure that the machine's ON/OFF mains switch is turned off and never connect the machine to the mains supply with the panels removed or damaged.
2. Insert the cable plug with electrode holder into the "+" socket on the front panel of the welding machine and tighten it clockwise.
3. Insert the cable plug of the work return lead into the "-" socket on the front panel of the welding machine and tighten it clockwise.

If you want to use long secondary cables (Electrode holder cable and/or earth cable), you must ensure that the cross-sectional area of the cable is increased appropriately in order to reduce the voltage drop due to the cable length.

Please Note:

Check these power connections daily to ensure they have not become loose otherwise arcing may occur when used under load.

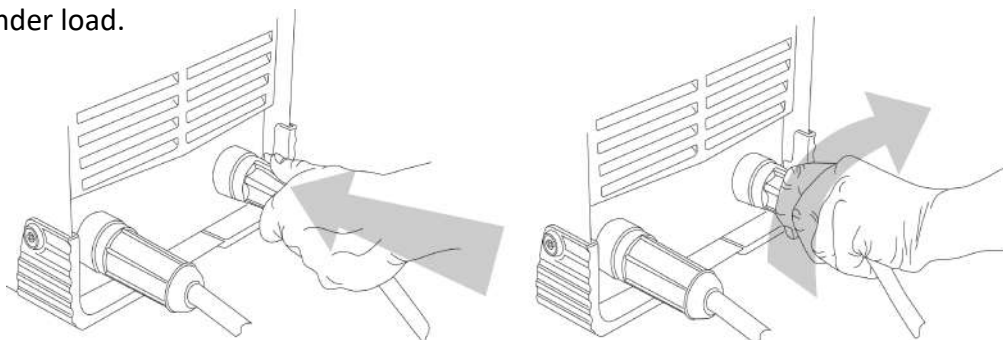

Generic library picture

OPERATION - MMA



Before starting any welding activity ensure that you have suitable eye protection and protective clothing. Also take the necessary steps to protect any persons within the welding area.

MMA welding

MMA (Manual Metal Arc), SMAW (Shielded Metal Arc Welding) or just Stick Welding. Stick welding is an arc welding process which melts and joins metals by heating them with an arc between a covered metal electrode and the work.

Shielding is obtained from the electrode outer coating, often called flux. Filler metal is primarily obtained from the electrode core.

The electrodes outer coating called flux assists in creating the arc and provides a shielding gas and on cooling forms a slag covering to protect the weld from contamination.

When the electrode is moved along the work piece at the correct speed the metal core deposits a uniform layer called the weld bead.

After connecting the welding leads as detailed above, plug your machine into the mains supply and turn 'ON' the machine, the power switch is located at the rear panel of the machine, place it to the "ON" position, the panel indicator will then light up, the fan may start to rotate as the welding machine powers up and the control panel will also light up to indicate that the machine is ready to use as shown below.

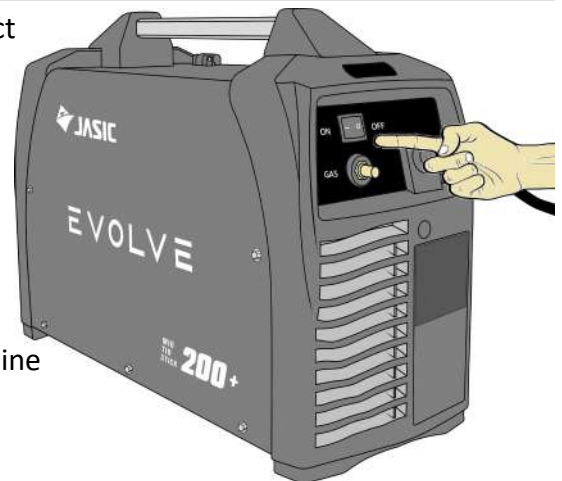
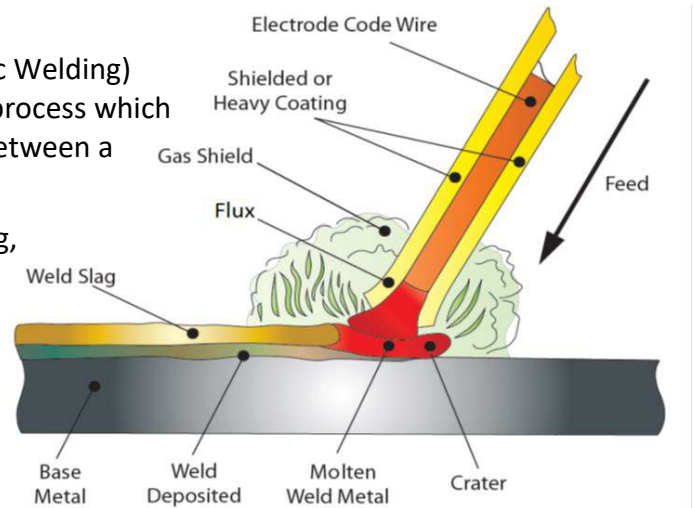

Caution, there is voltage output at both output terminals.

Please Note: The Evolve 200 is equipped with smart fan technology.

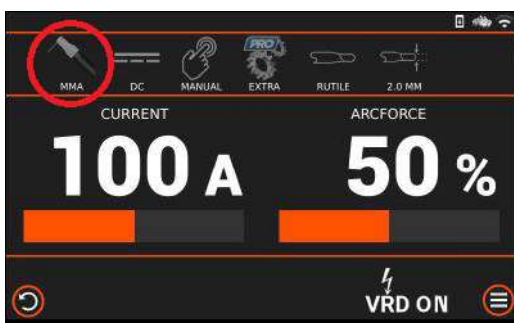

When the power supply is first turned on after a short period before welding starts, the fan will automatically start and then stop. The fan will then run automatically when welding begins or if the ambient temperature is too high.

Now you can connect the welding leads as shown in the image right, ensure you check that you have the electrode polarity correct to match the welding rod being used.

In the image above, you will note that MMA has been selected (circled red) and the MMA current is also shown and is adjusted via the left control dial which is previewed and set to 100 amperes as shown in the image above. MMA Arc Force is also shown and is adjusted via the right control dial and is previewed and set to 50% as shown above.

For remote control operation, which will allow the operator to use a range of remote control accessories, see page 120 for further information.

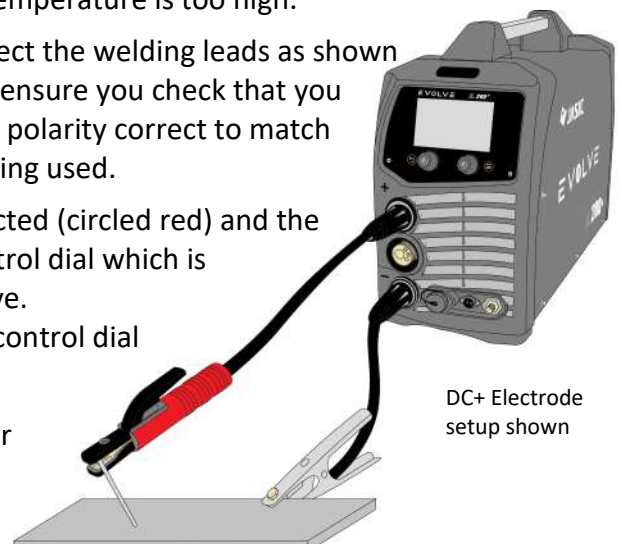

OPERATION - MMA



Before starting any welding activity ensure that you have suitable eye protection and protective clothing as, welding rays, spatter, smoke and high temperatures produced in the process may cause injury to personnel.

Also take the necessary steps to protect any persons within the welding area that may cause injury too.

MMA welding

Select MMA welding mode by pressing the welding mode icon (circled red), and from the drop down menu select MMA (other choices are TIG and MIG) the MMA icon will then be shown as in the image right (circled red).

When in MMA mode you can select and adjust welding current and arc force parameters respectively as described below.

MMA Welding Current Adjustment

MMA welding current adjustment can now be carried out via the panel control current dial A (as shown right) rotating the dial either clockwise or anticlockwise which will increase or decrease the welding amperage shown on the current display above the dial.

Please Note: Welding current adjustment can be carried out during welding.

Arc Force Current Adjustment

By default the left side of the display will show MMA current (as shown in the image above) and MMA arc force is shown to the right side of the display, you will also note that a slide bar below these parameters will also slide left/right when increased or decreased.

By rotating the right control dial clockwise or anticlockwise will increase or decrease the required arc force current until the desired arc force % is shown on the display.

The example above shows arc force percentage set & will offer up to 50% of the welding current shown.

Hot Start Current Adjustment

With the Evolve 200 the hot start value is related to arc force current. The more arc force you set the more hot start current you will experience when initialising the welding arc.

VRD indicator

In MMA mode, the VRD indicator will be shown (see image above) which indicate that VRD is active in MMA mode and the machines output voltage is limited to 14.3V when in idle mode.

Display Area Top Bar - MMA

This multi icon bar shows the operator a quick view of 'background' settings or The icons shown will change depending on MMA chosen settings.

Pressing the icons will allow entry to said setting.

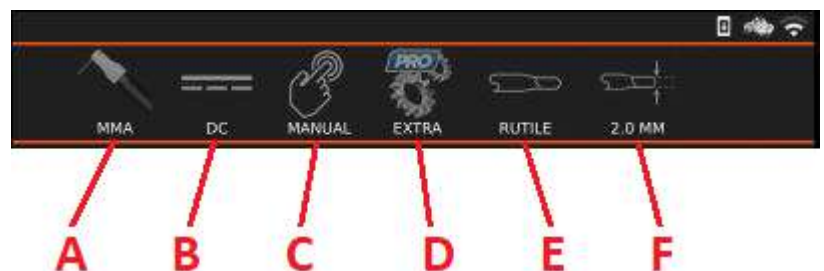

- A. The selected welding process indicator
- B. MMA type selected indicator (only DC output is available with the Evolve 200 model).
- C. Manual or Synergic mode indicator.
- D. Menu that offers additional function settings.
- E. MMA Electrode material type (functional only in synergic mode).
- F. MMA Electrode material size (functional only in synergic mode).

OPERATION - MMA



Before starting any welding activity ensure that you have suitable eye protection and protective clothing as, welding rays, spatter, smoke and high temperatures produced in the process may cause injury to personnel.

Also take the necessary steps to protect any persons within the welding area that may cause injury too.

To access the below options, you can either rotate the left hand control dial and confirm by pressing the left control dial OR by pressing the touch screen and sliding your finger to select your choice.

MMA - Manual or Synergic mode icon (C)

When selecting the Manual/Synergic icon, this option offers the user the following MMA weld mode choice:

- Manual - Standard MMA controls, set your parameters by adjusting Current and Arc Force.
- Synergic - The machine will calculate the optimal MMA settings based on the selected material thickness and electrode size.

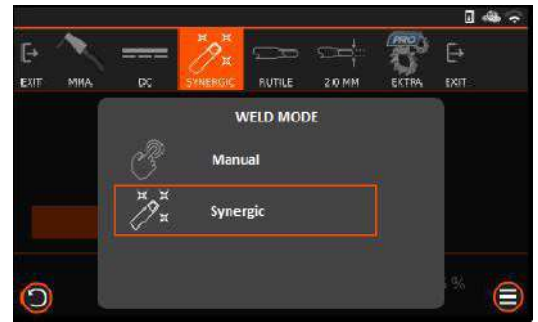

MMA - Advanced settings menu (D)

Pressing the EXTRA icon will enter the advanced settings menu. From here you can view additional options as follows:

1. VRD Delay Switch
2. Power Limit On/Off
3. Power Limit (functions only if Power Limit is ON)
4. Anti-sticking On/Off
5. MMA Auto Standby
6. Restore Default Settings

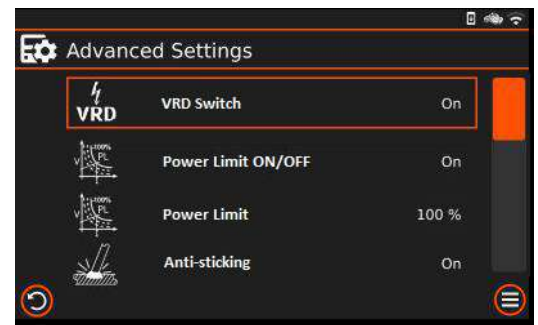

1. VRD Delay Switch:

VRD - (Voltage Reduction Device) is a hazard reducing circuitry inbuilt into welding power sources that is used in the MMA/Stick welding process.

This reduces the open circuit voltage (OCV) when the output of the power supply is ON but not welding to a safe voltage of 14.3V.

During welding, VRD is off and when the arc stops, the output voltage changes from welding voltage to no-load voltage and finally to VRD voltage, the time from no-load voltage to VRD voltage is called 'VRD delay time' and is around 300ms. With 'VRD OFF' it will prolong the time from 300ms to 30 seconds. Setting to 'VRD OFF' offers the higher re-ignition voltage if the arc is interrupted, assisting the operator to re-ignite the arc easier.



2. Power Limit On/Off:

In MMA mode, the output is constant current (CC), so voltage will change but current will stay constant. Power Limit mode, is a version of Constant Power, keeping the output power more stable, meaning that when voltage increases or decreases, current will be more constant. Power Limit mode benefits cellulosic electrode welding when current is between 100amps to 200amps.



3. Power Limit value:

This value can only be adjusted in the power limit has been turned ON is a proportion of power limit which can be adjusted from 0-100% and is the range of power limitation, as shown in the image right.

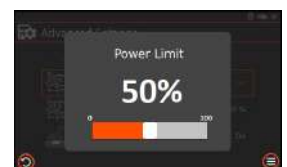

OPERATION - MMA



Before starting any welding activity ensure that you have suitable eye protection and protective clothing as, welding rays, spatter, smoke and high temperatures produced in the process may cause injury to personnel.

Also take the necessary steps to protect any persons within the welding area that may cause injury too.

To access the below options, you can either rotate the left hand control dial and confirm by pressing the left control dial OR by pressing the touch screen and sliding your finger to select your choice.

MMA - Advanced settings menu (D)

Pressing the EXTRA icon will enter the advanced settings menu. From here you can select 3 additional options as follows:

1. VRD Delay Switch
2. Power Limit On/Off
3. Power Limit setting (active if Power Limit is switched ON)
4. Anti-sticking mode On/Off
5. MMA Auto Standby
6. Restore Default Settings

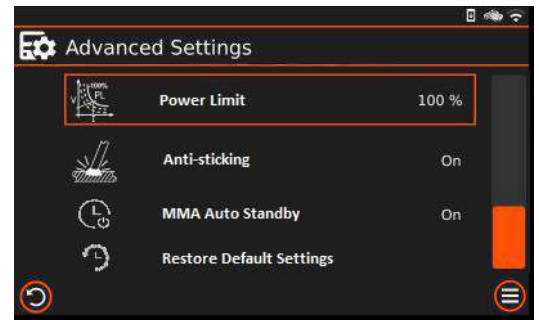

4. Anti-Sticking:

Anti-stick when turned 'ON' will assist in preventing the electrode from sticking and to be detached easily if it does begin to stick to the base metal.

When the machine senses that the electrode is sticking, it will reduce/stop the welding current to stop the electrode from continuing to weld itself to the base material and allowing it to break free easily.



5. MMA Auto Standby

When active or tuned ON in MMA, after a short period of time (30 seconds) when no welding activity has taken place the output will be deactivated and a pop up will appear in the screen stating 'Standby Mode Press to reactivate' pressing the screen will activate the MMA output again and the pop up warning will disappear.

Accessing the MMA Auto Standby option will allow you to turn ON or OFF this feature as shown in the image right.



6. Restore Default Settings

This option will restore the MMA parameters to the factory settings.

Accessing the MMA restore default settings option will pop open another window that allows the operator to restore MMA parameters to the factory settings by selecting 'yes' as shown right.

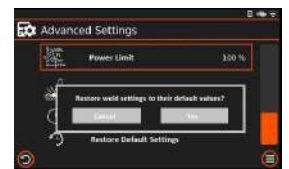

Please Note:

Depending on machine software version installed, the icon order and selection may differ.

OPERATION - MMA



Before starting any welding activity ensure that you have suitable eye protection and protective clothing as, welding rays, spatter, smoke and high temperatures produced in the process may cause injury to personnel.

Also take the necessary steps to protect any persons within the welding area that may cause injury too.

To access the below options, you can either rotate the left hand control dial and confirm by pressing the left control dial OR by pressing the touch screen and sliding your finger to select your choice.

When synergic weld mode is selected (see page 26) you can then proceed to select material type and electrode size which will setup the recommended parameters for the chosen material type and rod size.

MMA - Material type selection.

To select the required electrode type, press the material icon and from here you will have the option to select from four different electrode types as follows:

- Rutile - These electrodes have a high percentage of titanium oxide (rutile) in their coating. The HYPERARC General Purpose 6013 is a rutile electrode.
- SST - Stainless Steel electrodes, match the grade of Stainless Steel to your base material.
- Basic - These electrodes have a high percentage of limestone and fluorspar in their coating. Low Hydrogen electrodes, like the Hyperarc 16TC Low Hydrogen Electrode, are basic electrodes. These are used often in with critical welds.
- Cellulosic - These electrodes have a high percentage cellulose in their coating. They're known for being deeply penetrative (aggressive) electrodes, which is helped by the wood and paper fibres also in the flux. Examples include the 6010 and 6011 electrodes.



Once the desired electrode is selected the material icon will show which type was chosen.

MMA - Electrode (rod) size.

To select the electrode size being used, press the rod size icon as shown right and from here you will have the option to select from four different electrode sizes as follows:

- 2.0mm
- 2.5mm
- 3.2mm
- 4.0mm



Synergic settings for materials type versus electrode size.

Material Type	Electrode Size (mm)
Rutile	2.0, 2.5, 3.25, 4.0
SST	2.0, 2.5, 3.25, 4.0
Basic	2.5, 3.25, 4.0
Cellulosic	2.5, 3.25, 4.0

OPERATION - MMA



Before starting any welding activity ensure that you have suitable eye protection and protective clothing as, welding rays, spatter, smoke and high temperatures produced in the process may cause injury to personnel.

Also take the necessary steps to protect any persons within the welding area that may cause injury too.

The table below offers a current guide for various sizes of welding electrode diameters versus recommended current ranges.

The operator can set their own parameters based on the type and diameter of welding electrode and their own process requirements.

Electrode Size (mm)	Recommended Welding Current (A)
1.0	20 ~ 60
1.6	44 ~ 84
2.0	60 ~ 100
2.5	80 ~ 120
3.2	108 ~ 148
4.0	140 ~ 180

PLEASE NOTE:

- The operator should set the parameters that meet the welding requirements.
- If the selections are incorrect this may lead to problems such as an unstable arc, spatter or sticking of the welding electrode to the work piece.
- If the secondary cables (welding cable and earth cable) are long, select cable with larger cross-section to reduce the voltage drop.

MMA welding

Arc force:

Arc force prevents the electrode sticking when welding. Arc force provides a temporary increase in current when the arc is too short and helps maintain consistent excellent arc performance on a wide range of electrodes. The Arc force value should be determined according to welding electrode diameter, current setting, and process requirements. High arc force settings lead to a crisper, higher penetration arc but with some spatter. Lower arc force settings provide a smooth arc with lower spatter and a good weld seam formation, but sometimes the arc is soft or the welding electrode can stick.

Hot start current:

With the Evolve 200 hot start value is related to arc force current. The more arc force you set the more hot start current you will get.

Hot start current is an increase in welding current at the start of the weld to give excellent arc ignition and to avoid the electrode sticking. It also can reduce weld defects at the start of the weld.

The magnitude of hot start current is generally determined based on the type, specification, and welding current of welding electrode.

OPERATION - MMA



Before starting any welding activity ensure that you have suitable eye protection and protective clothing as, welding rays, spatter, smoke and high temperatures produced in the process may cause injury to personnel.

Also take the necessary steps to protect any persons within the welding area that may cause injury.

MMA welding

During welding:

During DC welding the heat on the positive and negative electrodes of the welding arc is different.

When welding using DC power supply, there are DCEN (DC electrode negative) and DCEP (DC electrode positive) connections.

The DCEN connection refers to the welding electrode connected to the negative electrode of the power supply and the work piece connected to the positive electrode of the power supply.

In this mode the work piece receives more heat, resulting in high temperature, deep molten pool, easy to weld through, suitable for welding thick parts.

The DCEP connection refers to the welding electrode connected to the positive power supply with the work piece connected to the negative power supply. In this mode the work piece receives less heat, resulting in low temperature, shallow pool, and difficulty in welding through. This is suitable for welding thin parts.

The Evolve 200 units have preset anti-stick function by default. In the welding process, if a short circuit occurs on the welding output for 2 seconds, the machine will automatically enter anti-stick mode.

This means the welding current will automatically drop to 20A to allow the short circuit to be cleared.

When the short circuit is cleared the welding current will automatically return to the set current.

Turn off the power supply after welding

On completion of any welding operating, the machine should be powered down.

The power switch is located on the rear panel of the machine and should be set to the "off" position.

It maybe noted that for a short period of time that the machines fan continues to run, this is quite normal and after a short time delay, the control panel lights indicator will turn off and the fan will stop indicating that the welder has now fully powered down.

It's also good practice to turn off the power at the machine socket outlet and fully disconnect the machine from the supply socket.

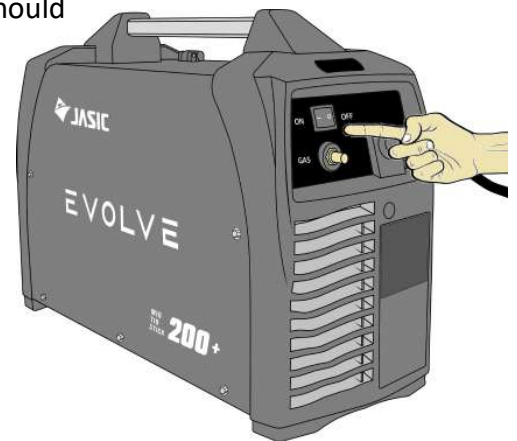

GUIDE TO MMA WELDING



Before starting any welding activity ensure that you have suitable eye protection and protective clothing. Also take the necessary steps to protect any persons within the welding area.

Notes for the welding beginner

This section is designed to give the beginner who has not yet done any welding some information to get them going. The simplest way to start is to practice by running weld beads on a piece of scrap plate. For example, start by using mild steel (paint free) plate of 6.0mm thick and using 3.2mm electrodes. Clean any grease, oil and loose scale from the plate and fix firmly to your work bench so that welding can be carried out.

Make sure that the work return clamp is secure and making good electrical contact with the mild steel plate, either directly or through the work table. For best results always clamp the work lead directly to the material being welding, otherwise a poor electrical circuit may create itself.

Welding position

When welding, ensure you place yourself in a comfortable position for welding and your welding application before you begin to weld. This maybe be sitting at a suitable height which often is the best way to weld ensuring you're relaxed and not tense. A relaxed posture will ensure the welding task becomes much easier.

Please ensure you always wear suitable PPE and use suitable fume extraction when welding.

Place the work so that the direction of welding is across, rather than to or from your body.

The electrode holder lead should always be clear of any obstruction so that you can move your arm freely along as the electrode burns down. Some elders prefer to have the welding lead over their shoulder, this allows greater freedom of movement and can reduce the weight from your hand.

Always inspect your welding equipment, welding cables and electrode holder before each use to ensure it's not faulty or worn as you may be at risk of an electric shock.

MMA process features and benefits

The versatility of the process and the skill level required to learn, basic simplicity of the equipment make the MMA process one of the most common used throughout the world.

The MMA process can be used to weld a wide variety of materials and is normally used in the horizontal position but can be used in vertical or overhead with the correct selection of electrode and current. In addition, it can be used to weld at long distances from the power source subject to the correct cable sizing.

The self shielding effect of the electrode coating makes the process suitable for welding in external environments. It is the dominant welding process used in maintenance, repair industries and is used extensively in structural and fabrication work.

The process is well able to cope with less than ideal material conditions such as dirty or rusty material. Disadvantages of the process are the short welds, slag removal and stop starts which lead to poor weld efficiency which is in the region of 25%.

The weld quality is also highly dependent on the skill level of the operator and many welding problems can exist.

GUIDE TO MMA WELDING



Before starting any welding activity ensure that you have suitable eye protection and protective clothing. Also take the necessary steps to protect any persons within the welding area.

MMA process tips and guides

Typical welder set up

1. Electrode holder
2. Work return clamp
3. Work piece
4. Weld material covered by electrode flux or slag
5. Electrode
6. Distance from work to electrode (arc Length)

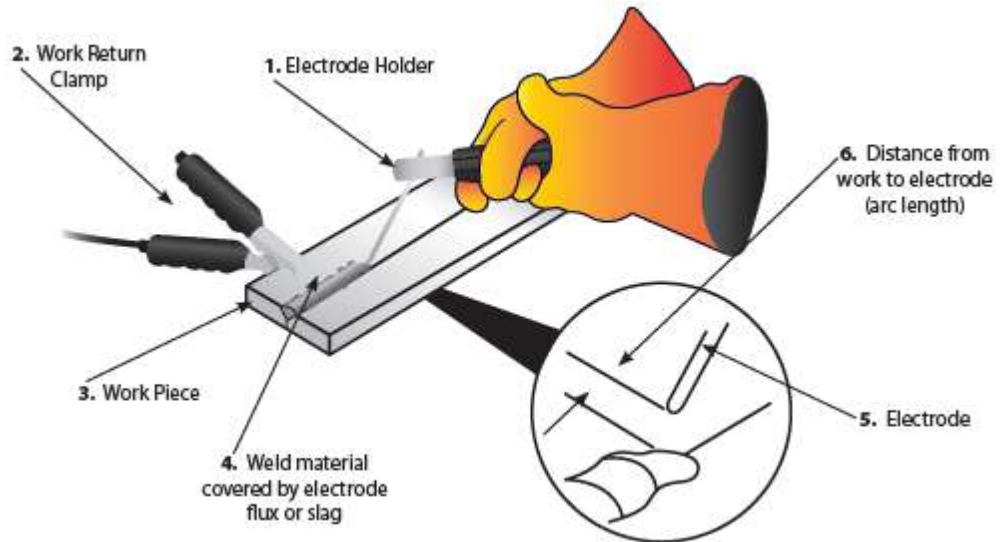

Welding current will flow in the circuit as soon as the electrode contacts the work piece.

The operator should always ensure a good connection of the work clamp. The nearer the clamp is placed to the welding area the better.

When the arc is struck the distance between the end of the electrode and the work will determine the arc voltage and also affect the weld characteristic. As a guide the arc length for electrodes up to 3.2mm diameter should be around 1.6mm and over 3.2mm around 3mm.

Upon completion of the weld the welding flux or slag will need to be removed usually with a chipping hammer and wire brush.

Joint form in MMA

In MMA welding, the common basic joint forms: butt joint, corner joint, lap joint and T joint.

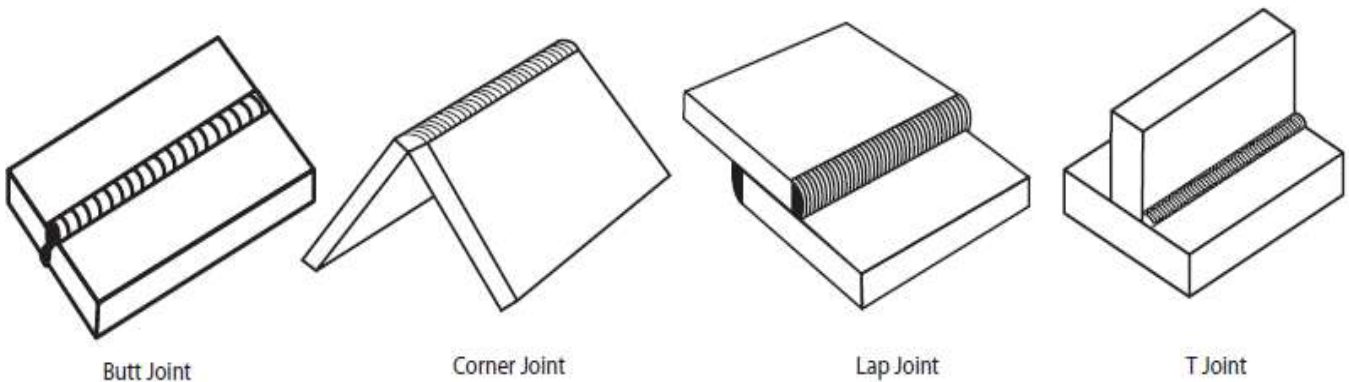

GUIDE TO MMA WELDING



Before starting any welding activity ensure that you have suitable eye protection and protective clothing. Also take the necessary steps to protect any persons within the welding area.

MMA arc striking

Tap Technique

Lift the electrode upright and bring it down to strike the work piece. After forming a short circuit, quickly lift up about 2 to 4mm and arc will be ignited. This method is difficult to master.

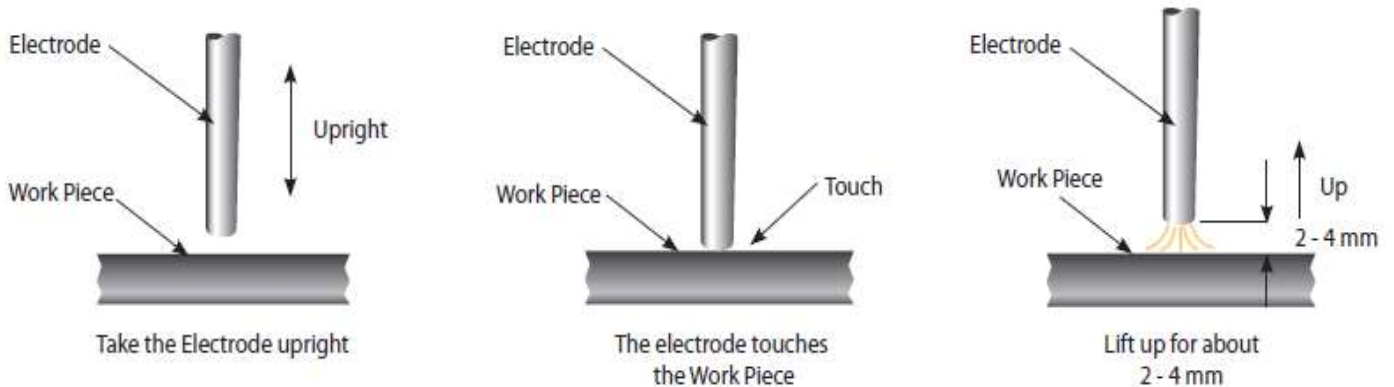

Scratch Technique

Drag the electrode and scratch the work piece as if striking a match. Scratching the electrode may cause the arc to burn along the scratch path, so care should be taken to scratch in the weld zone. When the arc is struck adopt the correct welding position.

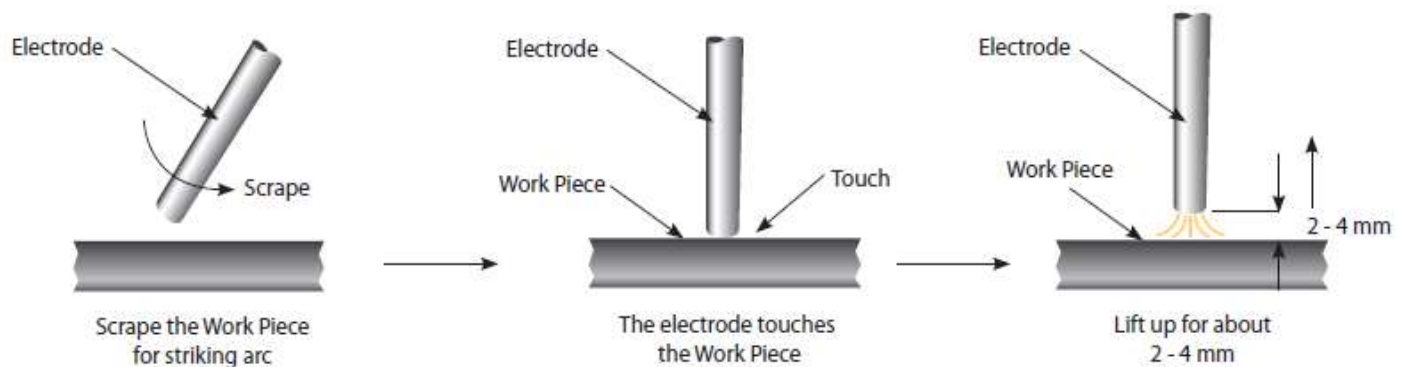

Electrode Positioning

Horizontal or flat position

The electrode should be positioned at right angles to the plate and inclined in the direction of travel at around $10^\circ \sim 30^\circ$.

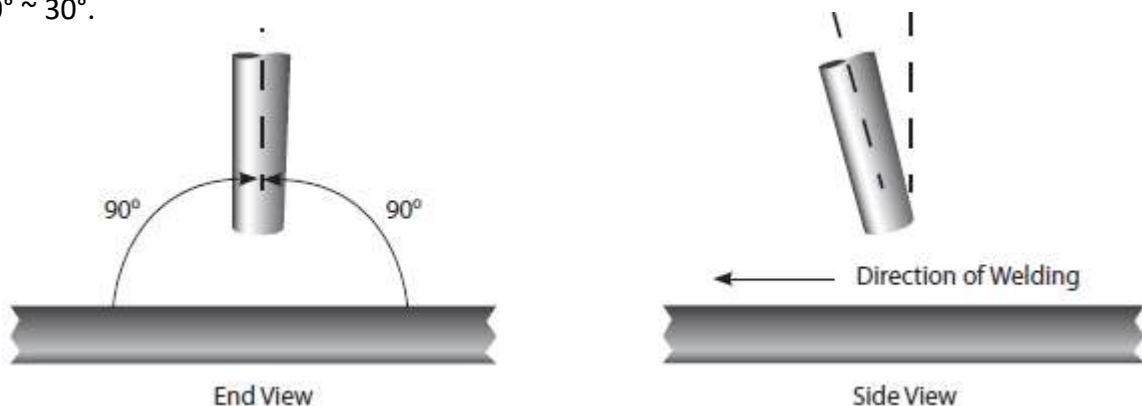

GUIDE TO MMA WELDING



Before starting any welding activity ensure that you have suitable eye protection and protective clothing. Also take the necessary steps to protect any persons within the welding area.

Fillet welding

The electrode should be positioned to split the angle i.e. 45° . Again the electrode should be inclined in the direction of travel at around 10° to 30° .

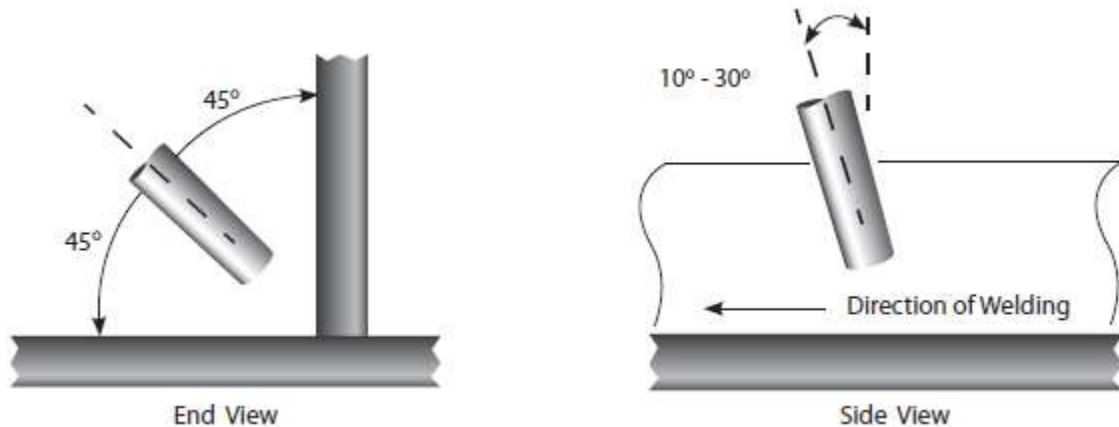

Manipulation of electrode

In MMA welding there are three motions used at the end of electrode:

1. The electrode feeding to the molten pool along axes
2. The electrode swing right and left
3. The electrode moving in the weld direction

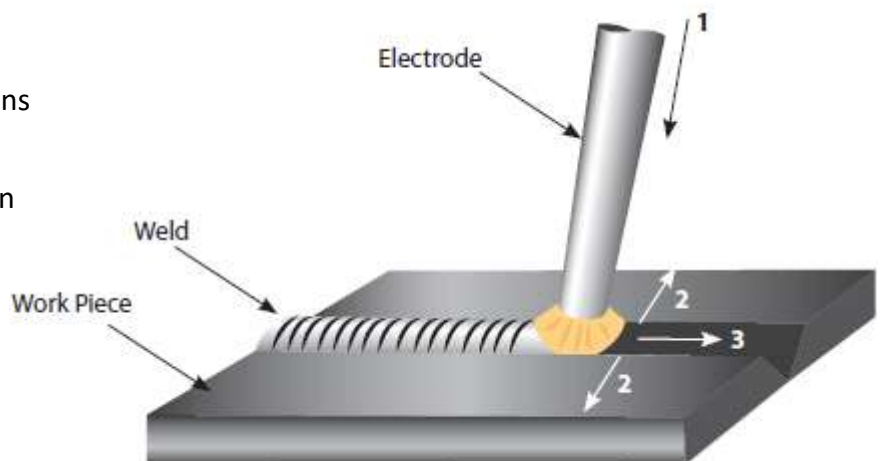

The operator can choose the manipulation of electrode based on welding joint, welding position, electrode spec, welding current and operation skill etc.

Weld characteristics

A good weld bead should exhibit the following characteristics:

1. Uniform weld bead
2. Good penetration into the base material
3. No overlap
4. Fine spatter level

A poor weld bead should exhibit the following characteristics:

1. Uneven and erratic bead
2. Poor penetration into the base material
3. Bad overlap
4. Excessive spatter levels
5. Weld crater

MMA WELDING TROUBLESHOOTING



Before starting any welding activity ensure that you have suitable eye protection and protective clothing. Also take the necessary steps to protect any persons within the welding area.

Arc welding defects and prevention methods

<u>Defect</u>	<u>Possible cause</u>	<u>Action</u>
Excessive spatter (beads of metal scattered around the weld area).	Amperage too high for the selected electrode.	Reduce amperage or utilise larger diameter electrode.
	Voltage too high or arc length too long.	Reduce arc length or voltage.
Uneven and erratic weld bead and direction.	Weld bead is inconsistent and misses joint due to operator.	Operator training required.
Lack of penetration – The weld bead fails to create complete fusion between material to be welded, often surface appears okay but weld depth is shallow.	Poor joint preparation.	Joint design must allow for full access to the root of the weld.
	Insufficient heat input.	Material too thick. Increase the amperage or increase the electrode size and amperage.
	Poor weld technique.	Reduce travel speed. Ensure the arc is on the leading edge of the weld puddle.
Porosity – Small holes or cavities on the surface or within the weld material.	Work piece dirty.	Remove all contaminant from the material i.e. oil, grease, rust, moisture prior to welding.
	Electrode is damp.	Replace or dry the electrode.
	Arc length is excessive.	Reduce the arc length.
Excessive penetration – The weld metal is below the surface level of the material and hangs below.	Heat input too high.	Reduce the amperage or use a smaller electrode and lower amperage.
	Poor weld technique.	Use correct welding travel speed.
Burning through – Holes within the material where no weld exists.	Heat input too high.	Use lower amperage or smaller electrode.
		Use correct welding travel speed.
Poor fusion – Failing of weld material to fuse either with the material to be welded or previous weld beads.	Insufficient heat level.	Increase the amperage or increase the electrode size and amperage.
	Poor welding technique.	Joint design must allow for full access to the root of the weld. Alter welding technique to ensure penetration such as weaving, arc positioning or stringer bead technique.
	Work piece dirty.	Remove all contaminant from the material i.e. oil, grease, rust, moisture prior to welding.

TIG SETUP



Before starting any welding activity ensure that you have suitable eye protection and protective clothing. Also take the necessary steps to protect any persons within the welding area.

TIG welding mode

Terms used: TIG – Tungsten Inert Gas, GTAW – Gas Tungsten Arc Welding.

TIG welding is an arc welding process that uses a non-consumable tungsten electrode to produce the heat for welding.

The weld area is protected from atmospheric contamination by a shielding gas (usually an inert gas such as argon or helium) and a filler rod matching the base material is normally used, though some welds, known as autogenous welds, are carried out without the need for filler wire.

The TIG welding process with the Evolve 200 is DC mode only for welding:

- Mild steel, stainless steel, copper etc.

Connect the TIG torch connector to the “-” quick socket on the machine panel and tighten it clockwise.

Connect the switch plug on the TIG torch to the corresponding socket on the machine panel, this is a quick connector so it is not necessary to turn the plug.

Insert the quick plug on the work return cable into the “+” quick socket on the machine front panel and tighten it clockwise. Firmly fix the ground clamp to the work piece.

Connect the TIG torch gas hose to the quick connector on the machine front.

Connect the gas hose to the gas inlet on the back panel of the machine.

The other end of the supply gas hose connects to the gas regulator on the cylinder.



Please Note:

1. When connecting welding cables, ensure that the machines ON/OFF mains switch is turned off and never connect the machine to the mains supply with the panels removed.
2. If you want to use long secondary cables (Electrode holder cable and/or earth cable), you must ensure that the cross-sectional area of the cable is increased appropriately in order to reduce the voltage drop due to the cable length.
3. Check these power connections daily to ensure they have not become loose otherwise arcing may occur when used underload as shown right.

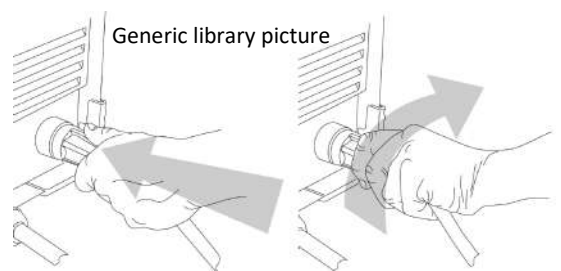

Switching Machine ON

When the power supply is first turned on after a short period before welding starts, the fan will initially start and then stop. The fan will then run automatically when welding begins or if the ambient temperature is too high.

Please Note:

If the torch trigger is pressed, TIG mode will automatically be selected, if you then access the Plug & Play and Accessories option in Machine Settings (page 17), you will note for example ‘UNKNOWN TORCH - TIG’ will be shown as a fitted accessory.

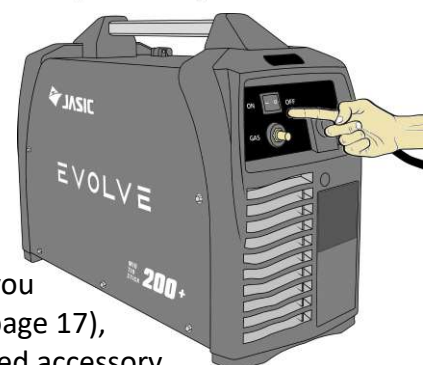

OPERATION TIG



Before starting any welding activity ensure that you have suitable eye protection and protective clothing. Also take the necessary steps to protect any persons within the welding area.

TIG welding mode

Terms used: TIG – Tungsten Inert Gas, GTAW – Gas Tungsten Arc Welding.

TIG welding is an arc welding process that uses a non-consumable tungsten electrode to produce the heat for welding.

The weld area is protected from atmospheric contamination by a shielding gas (usually an inert gas such as argon or helium) and a filler rod matching the base material is normally used, though some welds, known as autogenous welds, are carried out without the need for filler wire.

The TIG welding process with the Evolve 200 is DC mode only:
DC - Direct current for welding steel, stainless steel, copper etc.

Connect the TIG torch work return cable /ground clamp, gas hose and turn the machine on as shown on the previous page.

Please Note: The Evolve 200 is equipped with smart fan technology.

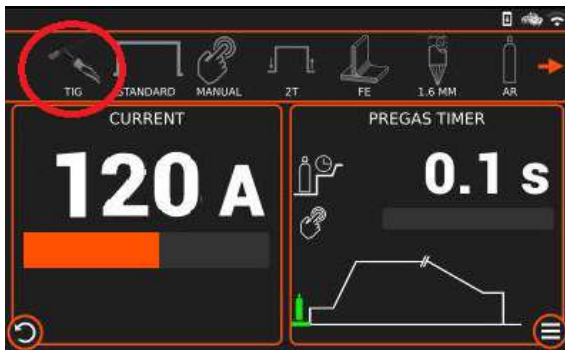
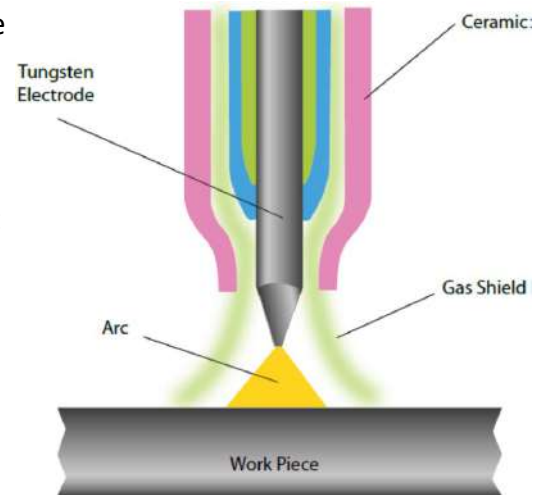

Once the machine has powered up, select TIG mode as detailed on page 22 and as shown in the image left (circled red). In the lower left section, preset current is shown and can be adjusted via the left control dial which is previewed and set to 120 amps as shown in the image left.

In the lower right hand section, the TIG pre-gas timer is shown and can be adjusted via the right control dial and is previewed and set to 0.1s as shown left.

For remote control operation, which will allow the operator to use a remote control accessory, see page 120 for further details.

Press the torch trigger briefly, the solenoid valve will operate and gas will flow.

Adjust the welding current according to the thickness of the work piece to be welded.

Hold the torch 2mm - 4mm away from the work piece and then press the torch trigger. Gas will flow and after the arc is ignited, the HF discharge will cease and the current will maintain the preset value and welding can be carried out.

After releasing the torch trigger, the welding arc will stop although the shielding gas continues flowing for the post flow time and welding ends.

TIG tungsten size will depend on material type, work piece thickness, welding position and joint form. See page 51 for further details.

Tungsten Size	DC – Electrode Negative
1.0mm	15 – 80A
1.6mm	70 – 150A
2.4mm	150 – 250A

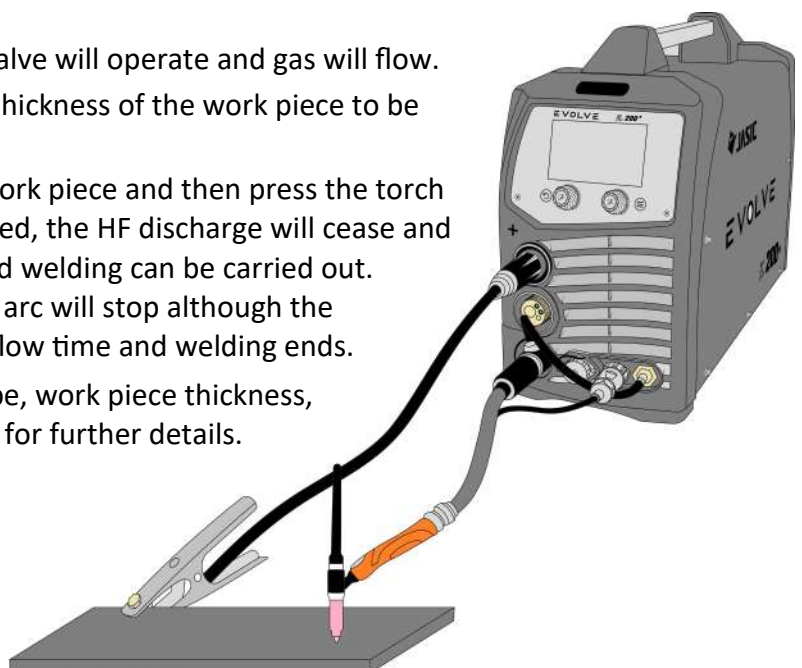

OPERATION TIG



Before starting any welding activity ensure that you have suitable eye protection and protective clothing. Also take the necessary steps to protect any persons within the welding area.

Display Area Top Bar - TIG Mode

This multi icon bar shows the operator a quick view of TIG options and settings. The icons shown will change depending on TIG background settings. Pressing the icons will allow entry to chosen setting.

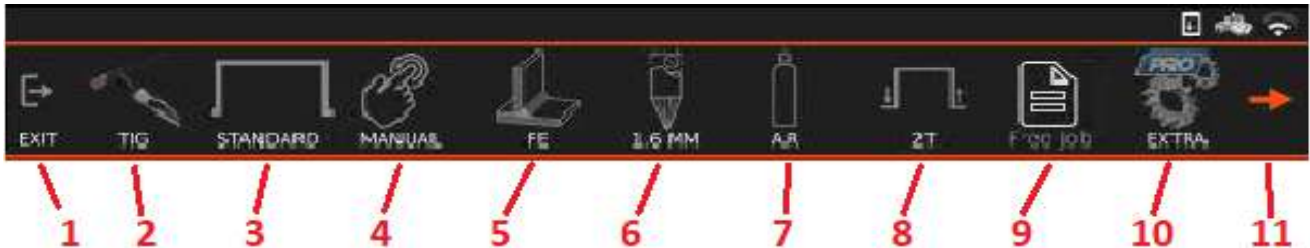

1. Pressing the **EXIT** button on the top bar menu will take you back to the TIG welding screen.



2. **TIG Mode:** The selected welding process indicator



3. **TIG Standard, Pulse or Mix mode selection button.**

Pushing the button will allow you to change from standard TIG to Pulse TIG and Mix TIG welding modes and upon selecting your chosen mode, the corresponding indicator will be shown in the top menu bar.

- Standard: Selects standard TIG welding.
- Pulse TIG: TIG welding with pulse that alternates between the peak and the base current.
- Mix TIG: TIG welding mode that adds a vibration to the weld cycle which aids welding with larger gaps in the workpiece.



4. **Manual or Synergic mode indicator.**

Pushing the button will allow you to change from TIG manual mode to TIG synergic mode and when chosen mode, the corresponding indicator will be shown in the top menu bar.

- Manual: Standard TIG controls, the operator will select the required parameters by adjusting Current and Weld Cycle.
- Synergic: Synergic TIG software will calculate the optimal settings based on the operators selected wire, gas and material thickness.

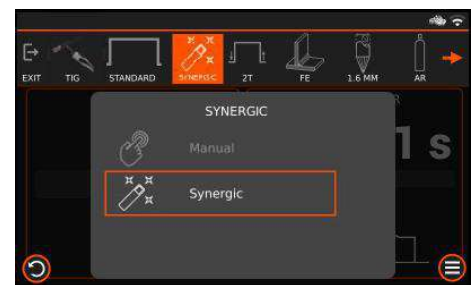

5. **Material type (Synergic Mode Only)**

Pushing the button allows access to select the base material being welded.

- FE: Mild Steel
- CRNI: Stainless Steel
- NICKEL: Nickel
- or TITAN: Titanium



Please Note:

Depending on machine software version installed, the icon order and selection may differ from what is shown either in this manual or the product you have, for example; some units may display Titan (Titanium) where as some models may show Nickel or even possibly other material names.

OPERATION TIG



Before starting any welding activity ensure that you have suitable eye protection and protective clothing. Also take the necessary steps to protect any persons within the welding area.

Display Area Top Bar - TIG (continued)

This multi icon bar shows the operator a quick view of TIG options and settings. The icons shown will change depending on TIG background settings. Pressing the icons will allow entry to chosen setting.



6. TIG Tungsten size selection button. (Synergic Mode Only)

Pushing the icon button allows the operator to change the TIG tungsten size being used, upon selecting your chosen size, the corresponding indicator icon will be shown in the top menu bar.

- 1.6mm
- 2.4mm

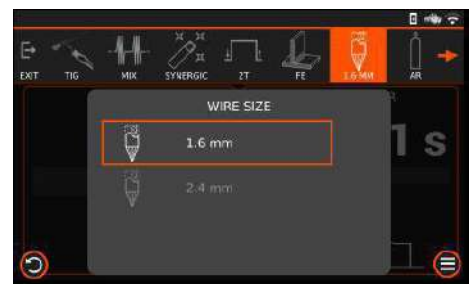

7. TIG welding gas: (Synergic Mode Only)

Pressing the gas selection icon button allows the operator to change the TIG welding gas, the chosen gas corresponding icon will be shown in the top menu bar, as shown right.



8. TIG torch trigger mode:

Pushing this icon button allows access to change the TIG torch trigger mode from 2T, 4T and spot welding mode, when chosen the corresponding indicator will be shown in the top menu bar.

- 2T (2 touch) You need to press and hold the button down on your TIG torch to weld, releasing will stop welding.
- 4T (4 touch/latch) You only need to press the button to initiate welding, release to continue welding and to stop welding, press and release again and welding will stop.
- Spot: Spot welding mode give consecutive, evenly timed welds that offers perfectly even tacks and small welds.



See pages 44 - 46 for further details on trigger mode functionality.

9. Memory function:

The Evolve 200 is capable of storing 100 TIG Jobs in it's memory and the jobs menu can be accessed from pressing the job menu icon as shown left. If a Job is selected, the reference number of the Job is showing in the icon display. If Free Job shows, this indicate that no job is selected.



- Load job
- Save Current Settings as a Job
- Reset Job to original values
- Return to Free Job

See page 20 for further details on saving and recalling jobs.

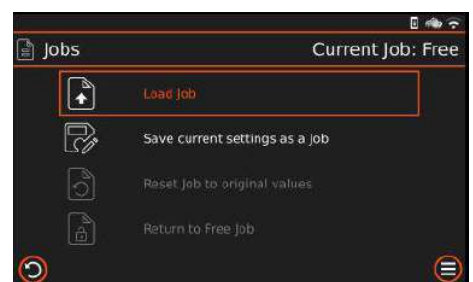

OPERATION TIG



Before starting any welding activity ensure that you have suitable eye protection and protective clothing. Also take the necessary steps to protect any persons within the welding area.

Display Area Top Bar - TIG (Continued)

This multi icon bar shows the operator a quick view of TIG options and settings. The icons shown will change depending on TIG background settings. Pressing the icons will allow entry to chosen setting.

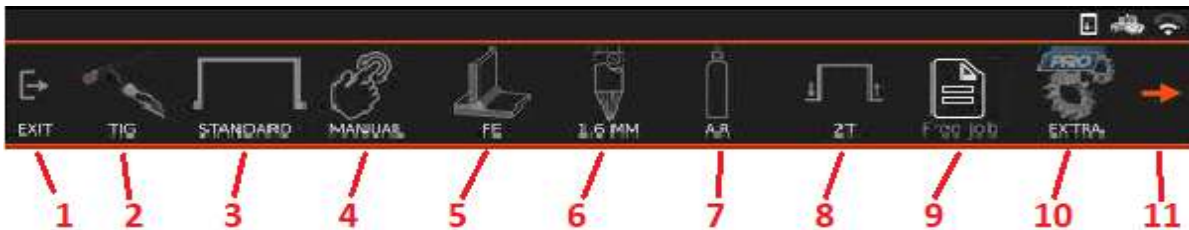

10. TIG - Advanced settings menu

Pressing the EXTRA icon will enter the advanced settings menu, from here you can select various additional TIG options as shown right. Rotating and pressing the left control dial will allow you to select, adjust and save parameter settings.

Please Note:

The advanced options listed will depend on a number of factors, for example you have TIG Pulse, TIG Mix or Spot mode selected you would see additional options listed than if you had TIG standard selected. You may also note that some functions are locked, this is because some settings will only adjust in manual mode rather than in Synergic mode. TIG Advanced settings list, values and description are as shown below.

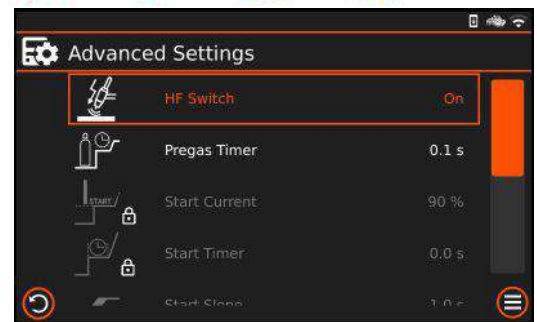

Setting	Value	Description
• TIG HF Switch	On/Off	Setting to use High Frequency or Lift TIG start.
• Pregas Time	0.1 - 10s	Setting for how long your shielding gas flow before the arc ignition.
• Start Current	20 - 150%	Set the starting current when on initial arc ignition.
• Start Time	0 - 10s	Time setting for the duration of the start current.
• Start Slope	0 - 10s	Slope up current time before reaching the peak welding current.
• Pulse Frequency	0.5 - 1000Hz	Set the number of pulses per second.
• Pulse Balance	25 - 75%	Set the percentage of each pulse spent in peak current.
• Pulse Softness	On/Off	Turns pulse softness on or off during welding.
• Pulse Low Current	20 - 80%	Set the base (lower) current value when in pulse mode.
• Mix Frequency	0.1 - 5Hz	Set the frequency of the Mix cycle. A higher value is recommended for fillet welds, a lower value is recommended for butt welds.
• Mix Balance	80 - 95%	Set the percentage of the Mix vibration of the weld cycle.
• Mix Softness	On/Off	Turn Off/On to adjust the sound of the weld.
• Stop Slope	0 - 20s	Slope down current time before reaching final current.
• Stop Current	20 - 80%	Setting for final current.
• Stop Time	0 - 10s	Time setting for final current duration.
• GLICK Level	20-90% / Off	GLICK function allows you to adjust welding current during 4T TIG mode. Pressing the torch trigger when welding will reduce the output to the % setting as determined by Glick setting.
• Postgas Time	0.5 - 25s	Sets the period of time shielding gas will flow once arc ignition stops.
• Restore Default Settings		Restores welding parameters to factory setting.

OPERATION TIG



Before starting any welding activity ensure that you have suitable eye protection and protective clothing. Also take the necessary steps to protect any persons within the welding area.

TIG - Advanced settings menu (continued)

Please Note:

The advanced options listed will depend on a number of factors, If for example you have TIG Pulse, TIG Mix or Spot mode selected you would see additional options listed than if you had TIG standard selected. You may also note that some functions are locked, this is because some settings will only adjust in manual mode rather than in Synergic mode.

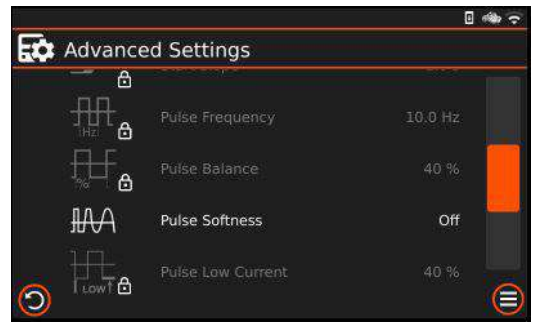

The list below details all option possible regardless of what TIG mode or options are selected.

HF Switch:

TIG starting mode selection switch (contact or non contact ignition): When you select this setting, you can either select HF arc start ignition or lift arc ignition in TIG mode. Pressing and the rotating the left dial will allow you to select HF or Lift TIG mode.

Pregas Timer:

Select the pre flow time setting function by rotating the left control dial until pre gas is highlighted, pressing and then rotating the left dial will allow you to adjust and set the pre flow time in seconds.

Start Current:

Select the initial current setting function by rotating the left control dial until start current is highlighted, pressing and then rotating the left dial will allow you to adjust and set the initial current.

Start Timer:

Select the start timer setting function by rotating the left control dial until start timer is highlighted, pressing and then rotating the left dial will allow you to adjust and initial current time in seconds.

Start Slope: (Up slope)

Select the upslope time setting function by rotating the left control dial until start slope is highlighted, pressing and the rotating the left dial will allow you adjust the slope up time in seconds.

Pulse Frequency:

When in TIG pulse mode, Select pulse frequency setting function by rotating the left control dial until pulse frequency is highlighted, pressing and the rotating the left dial will allow you adjust pulse frequency in Hz.

Pulse Balance:

When in TIG pulse mode, Select pulse balance setting function by rotating the left control dial until pulse balance is highlighted, pressing and the rotating the left dial will allow you adjust pulse balance in percentage.

Pulse Softness:

When in TIG pulse mode, Select pulse softness setting function by rotating the left control dial until pulse softness is highlighted, pressing and the rotating the left dial will allow you to turn on/off pulse softness mode.

Pulse Low Current:

When in TIG pulse mode, Select pulse balance setting function by rotating the left control dial until pulse balance is highlighted, pressing and the rotating the left dial will allow you adjust pulse balance in percentage.

OPERATION TIG



Before starting any welding activity ensure that you have suitable eye protection and protective clothing. Also take the necessary steps to protect any persons within the welding area.

TIG - Advanced settings menu (continued)

Please Note:

The advanced options listed will depend on a number of factors, If for example you have TIG Pulse, TIG Mix or Spot mode selected you would see additional options listed than if you had TIG standard selected. You may also note that some functions are locked, this is because some settings will only adjust in manual mode rather than in Synergic mode.

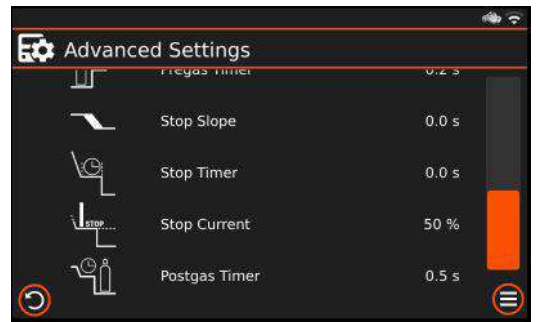

The list below details all option possible regardless of what TIG modes you have selected:

Mix Frequency

When in TIG mix mode, Select mix frequency setting function by rotating the left control dial until mix frequency is highlighted, pressing and the rotating the left dial will allow you adjust mix frequency in Hz.

Mix Balance

When in TIG mix mode, Select mix balance setting function by rotating the left control dial until mix balance is highlighted, pressing and the rotating the left dial will allow you adjust mix balance in percentage.

Mix Softness

When in TIG Mix mode, Select mix softness setting function by rotating the left control dial until mix softness is highlighted, pressing and the rotating the left dial will allow you to turn on/off mix softness mode.

Stop Slope: (Downslope)

Select the stop slope time setting function by rotating the left control dial until stop slope is highlighted, pressing and the rotating the left dial will allow you to adjust the downslope time in seconds.

Stop Timer:

Select the stop timer setting function by rotating the left control dial until start timer is highlighted, pressing and then rotating the left dial will allow you to adjust and final current time.

Stop Current: (Final current)

Select the initial current setting function by rotating the left control dial until start current is highlighted, pressing and then rotating the left dial will allow you to adjust and set the initial current.

GLICK Level:

When in TIG 4T mode, Select Glick level setting function by rotating the left control dial until Glick level is highlighted, pressing and the rotating the left dial will allow you to turn Glick level on/off.

Post Gas Timer:

Select the post flow time setting function by pressing the adjustment control knob until post gas is highlighted and then rotating the left dial will allow you to adjust post flow gas time in seconds.

Restore Default Settings:

Selecting Parameter reset to factory settings is done by rotating the left control dial until restore default settings is highlighted, pressing and then rotating the left dial will allow you to restore all TIG weld settings to their default factory settings.

OPERATION TIG



Before starting any welding activity ensure that you have suitable eye protection and protective clothing. Also take the necessary steps to protect any persons within the welding area.

TIG welding parameter settings

Please remember that the advanced options listed will depend on a number of factors, if for example you have TIG Pulse, TIG Mix or Spot mode selected you would see additional options listed than if you had TIG standard selected. You may also note that some functions are locked, this is because some settings will only adjust in manual mode rather than in Synergic mode.

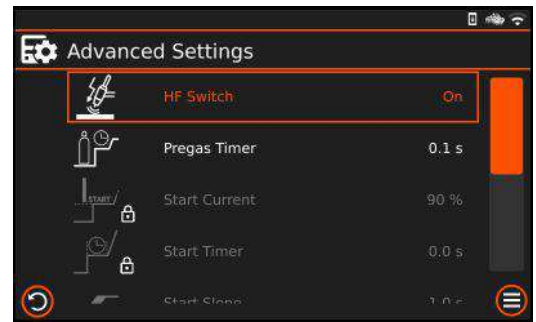

TIG welding

Select TIG welding mode by pressing the welding mode icon (circled red), and from the drop down menu select TIG (other choices are MMA and MIG) and the TIG icon will then be shown as in the image right (circled red).

TIG Welding Current Adjustment

TIG welding current adjustment can now be carried out via the panel control current dial A (as shown right) rotating the dial either clockwise or anticlockwise which will increase or decrease the welding amperage (200A as shown right) will be displayed within the current display above the left control dial.

Welding current adjustment can be carried out during welding.



TIG Welding Parameters Adjustment

As shown in the previous pages (40-42), you can select and adjust various TIG parameters with the right control dial which are shown in the right display area of the user screen such as pre-gas time, start current, start time, slope up and slope down times, final current, final current time and post-gas time as well as Pulse and Mix features if these modes have been activated.

As shown in the example right, the Pregas timer is shown and the value set is 0.1 seconds.



To select the various parameter settings, rotate the right control dial and as you rotate clockwise or anti-clockwise the parameter icon will be highlighted green.

Once the parameter icon is highlighted green, press left control dial and you will note that the Pregas time is now orange and that again in colour area of the until start slope is highlighted, pressing and then rotating the right control dial clockwise or anti-clockwise will adjust the value of the chosen parameter. When adjusting the chosen parameter the value change will also be noted by the orange bar below increasing or decreasing in length accordingly.



TIG TORCH TRIGGER FUNCTION



Before starting any welding activity ensure that you have suitable eye protection and protective clothing. Also take the necessary steps to protect any persons within the welding area.

TIG Torch Trigger Operation

2T mode (normal trigger control)

The 2T icon located in the top bar will be highlighted when the power source is in 2T welding mode. In this mode, the TIG torch trigger must remain pressed (closed) for the welding output to be active.

Press and hold the torch trigger to activate the power source, the gas valve and gas will flow. After the gas pre flow time ends, the welding arc will ignite when the tungsten touches and then is retracted from the work piece and then the current rises up (slope up time) to the welding current value gradually until you achieve the preset welding current.

When the torch switch is released, the current begins to drop gradually (slope down time) and when it drops to the minimum current value, the welding output is cut off and the gas valve will close, once the post flow time ends, this is the end of the welding process. If the torch switch is pressed down during the current downslope period, the current will rise up again to the preset welding current value and the slope out process will only start again once the torch switch to be released.

Please Note: 2T control is available for both TIG and MIG welding modes.

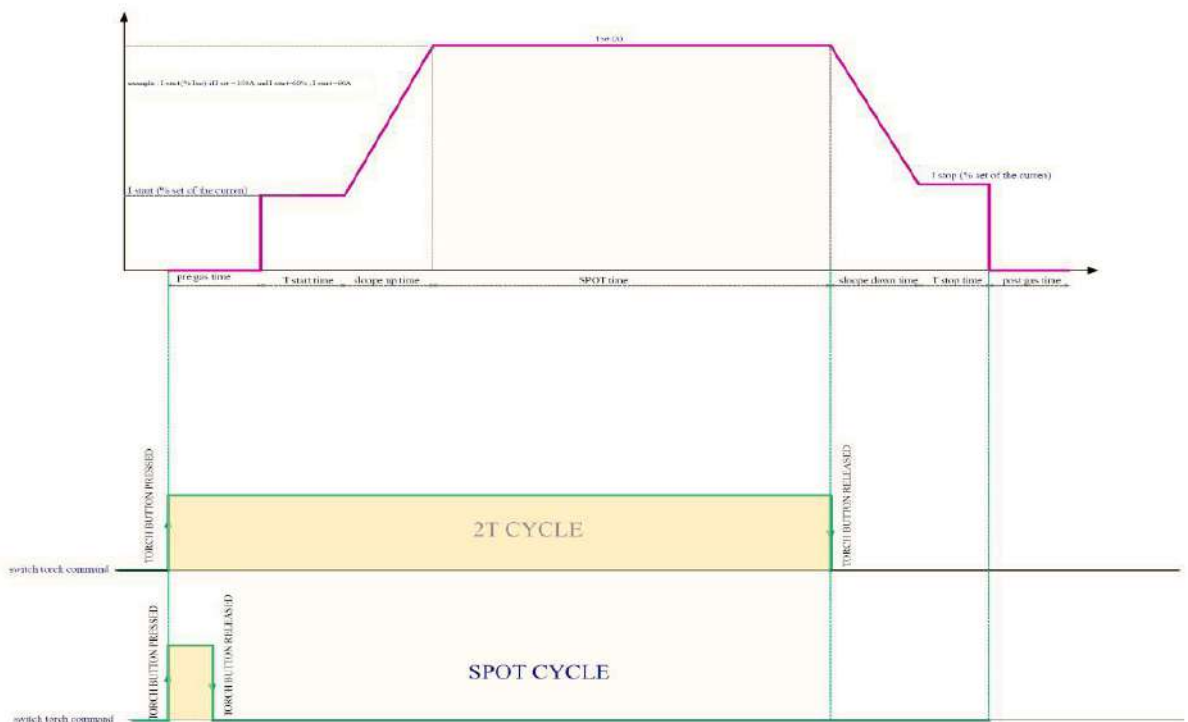

Spot Time

The spot time icon located in the top bar will be highlighted when the power source is in spot mode welding mode.

In this mode, the TIG torch trigger must remain pressed (closed) for the welding output to be active.

Press and hold the torch trigger to activate the power source, the gas valve and gas will flow. After the gas pre-flow time ends, the welding arc will ignite and the welding current rises to the preset welding current value.

Once the preset spot time has elapsed the welding arc will spot and once the post gas time has finished you can then remove the TIG torch from the welding area.

Please Note: Spot mode control is available for both TIG and MIG welding modes.

TIG TORCH TRIGGER FUNCTION



Before starting any welding activity ensure that you have suitable eye protection and protective clothing. Also take the necessary steps to protect any persons within the welding area.

TIG Torch Trigger Operation (continued)

4T (latch trigger control)

The 4T icon located in the top bar will be highlighted when the power source is in 4T welding mode, this trigger mode is mainly used for long welding runs to assist in reducing operator finger fatigue.

In this mode the user can press and release the TIG torch trigger and the output will remain active until the trigger switch is depressed again and released.

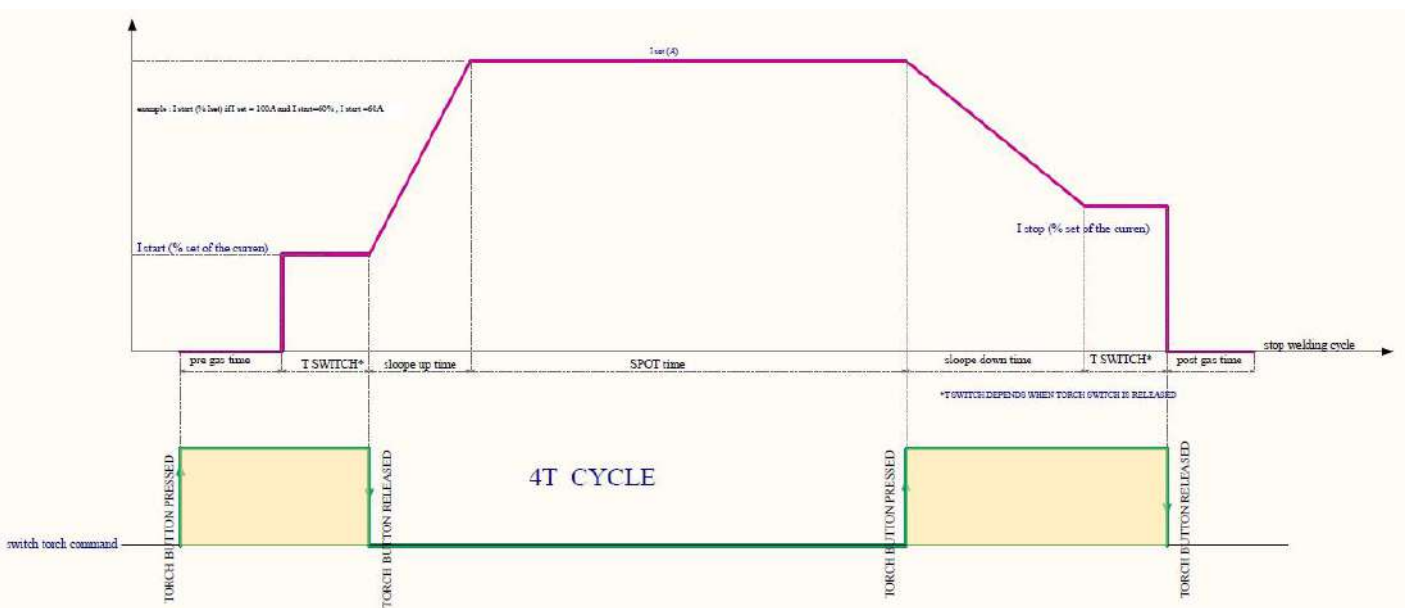

In 4T mode, the gas valve opens when the torch switch is pressed down, after the pre flow time ends, the welding arc will ignite when the tungsten touches and then is retracted from the work piece.

Once the welding arc has successfully ignited the initial current value is active and the torch switch can now be released, the welding current rises up to the preset welding current value gradually and you will continue to weld your material.

To finish welding, simply press the torch switch down again and the current will begin to gradually drop (slope out time) to the final current value.

When the torch switch is released the current output is cut off and the gas will continue to flow until your preset post flow time has elapsed.

Please Note: 4T control is available for both TIG and MIG welding modes.

TIG TORCH TRIGGER FUNCTION



Before starting any welding activity ensure that you have suitable eye protection and protective clothing. Also take the necessary steps to protect any persons within the welding area.

TIG Torch Trigger Operation (continued)

4T Glick mode, also called 'cycle' mode), is a function that is available and active in 4T mode only. Glick Mode, is available in the following modes:

- 4T TIG Standard, Pulse and MIX welding Modes
- 4T MIG Synergic, Pulse and Double Pulse welding Modes

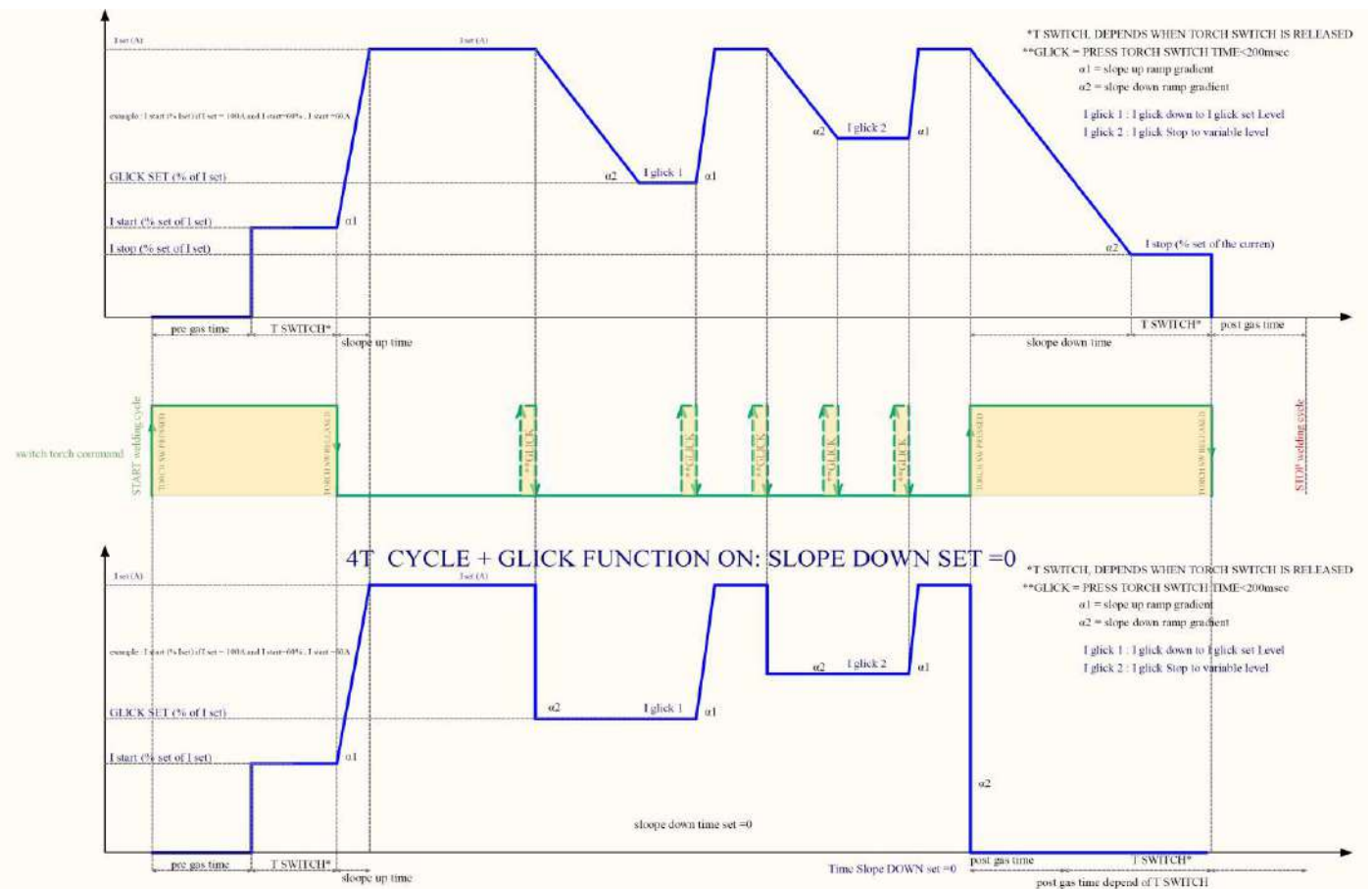

When the power source is in Glick (repeating) mode, upon pressing the TIG torch trigger switch the gas valve opens and after the pre flow time ends, HF discharge will engage the welding arc.

Once the welding arc is ignited successfully, the initial current is present then after the operator releases the torch switch the welding current rises up to the preset welding current value gradually (depending on preset upslope time). When the torch switch is pressed down again, the current begins to drop gradually to the final current arc value.

When the torch switch is released again, the current will rise gradually up to the welding current value again.

'Glick mode' means the welding current varies between the final arc current value and the welding current value.

To extinguish the welding arc, press and release the torch trigger briefly (within 1/5 of a second) and the arc will be extinguished immediately and the current output will be shut off.

The gas valve will then close when the post flow time ends and the welding process ends.

In Glick mode, if slope up or slope down is active, then the current will slope either up or down (depending on slope settings) when you switch between amperage settings.

EVOLVE 200

TIG DC - Quick Set-Up Guide

For DC TIG welding, set up as below, ensure you place the machine in TIG, HF ON and 2T trigger mode.

This multi icon bar shows the operator a quick view of TIG options and settings. The icons shown will change depending on TIG background settings. Pressing the icons will allow entry to chosen setting.

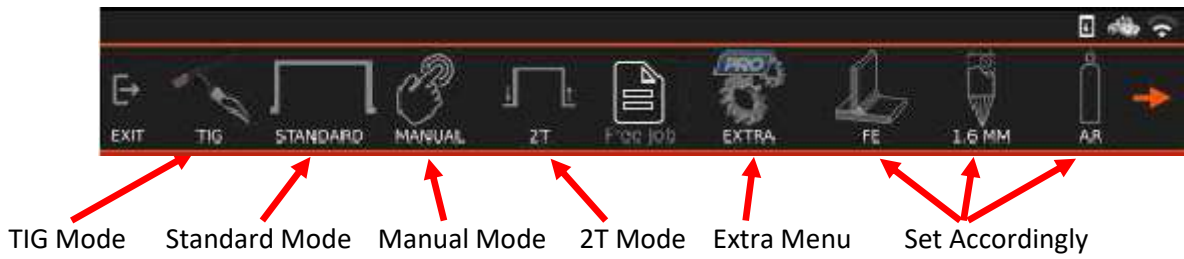

Pressing the EXTRA icon will open up the advanced settings menu, from here you can select various additional TIG options as shown in the below table.

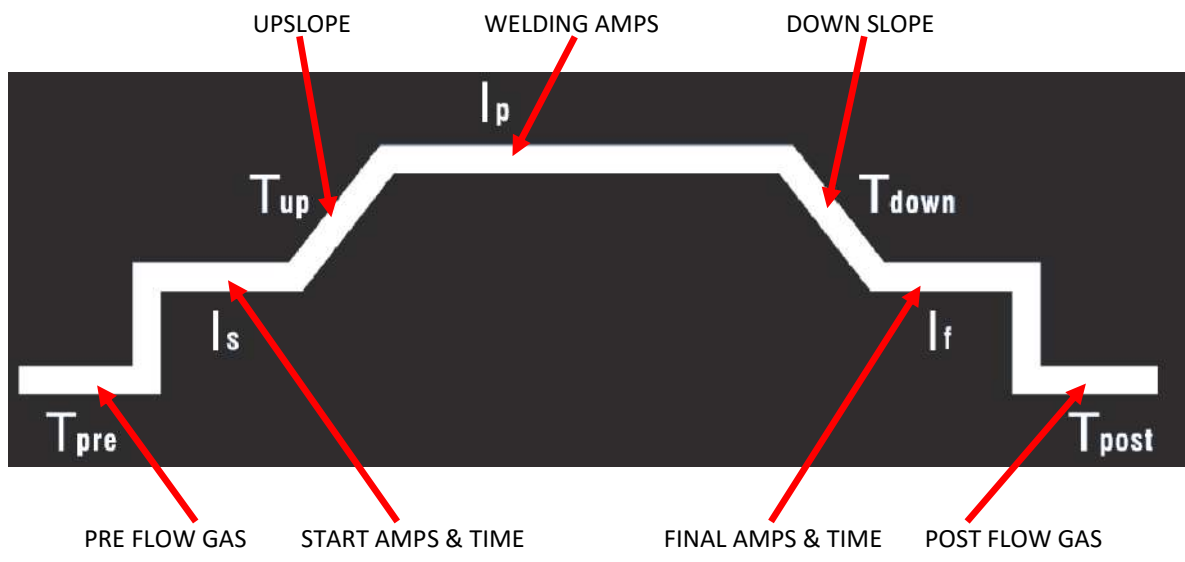

Rotating and pressing the left control dial will allow you to select, adjust and save TIG parameter settings. You can also use the touch screen to navigate through and adjust settings as recommended below.

Parameter	Units	Adjustable Range	Guide Setting	User Setting
Job/Material	---	---	---	
HF Switch *	N/A	On or Off	ON	
PRE-GAS TIME	Seconds	0.1 ~ 10	0.5	
START CURRENT	% (of peak)	20 ~ 150	20	
START CURRENT TIME	Seconds	0 ~ 10	0	
UP-SLOPE TIME	Seconds	0 ~ 10	0	
PEAK WELDING CURRENT **	Amps	5 ~ 200	User defined *	
DOWN-SLOPE TIME	Seconds	0 ~ 20	1	
FINAL CURRENT	% (of peak)	20 ~ 80	20	
FINAL CURRENT TIME	Seconds	0 ~ 10	1	
POST-GAS TIME	Seconds	0 ~ 15	2	

* Some of the above settings are accessed and adjusted from the Extra Menu as shown in the top image.

** Depends on material thickness (30A per mm) eg. 3mm = 90A.

EVOLVE 200

TIG PULSE DC - Quick Set-Up Guide

For DC TIG Pulse welding, set up as below ensure you place the machine in TIG pulse, HF ON and 2T trigger mode.

This multi icon bar shows the operator a quick view of TIG options and settings. The icons shown will change depending on TIG background settings. Pressing the icons will allow entry to chosen setting.



TIG Mode Pulse Mode Manual Mode 2T Mode Extra Menu Set Accordingly

Pressing the EXTRA icon will open up the advanced settings menu, from here you can select various additional TIG options as shown in the below table.

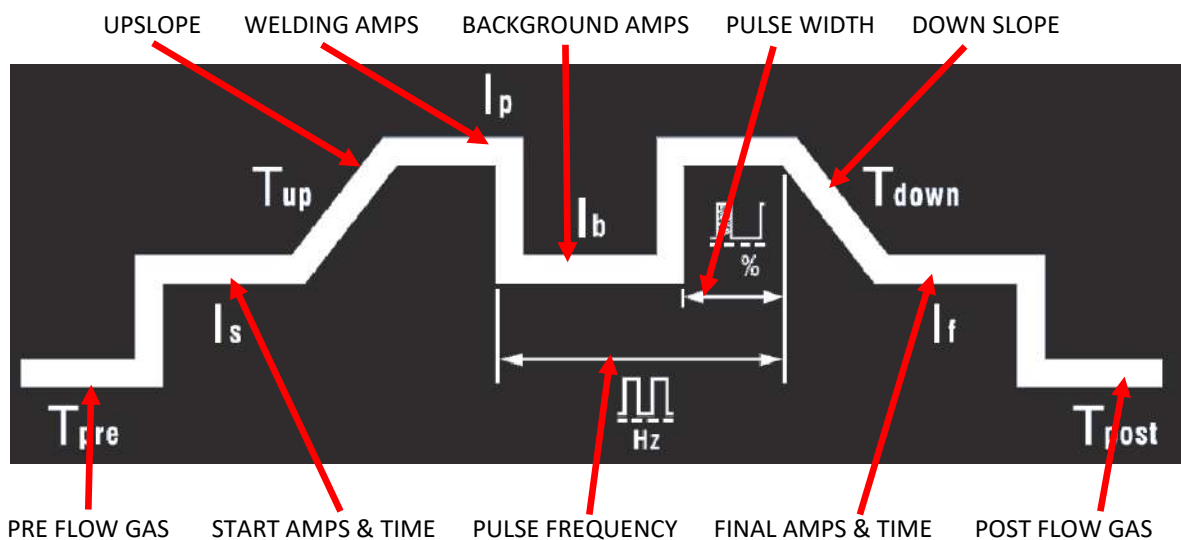

Rotating and pressing the left control dial will allow you to select, adjust and save TIG parameter settings. You can also use the touch screen to navigate through and adjust settings as recommended below.

Parameter	Units	Adjustable Range	Guide Setting	User Setting
Job/Material	---	---	---	
HF Switch *	N/A	On or Off	ON	
PRE-GAS TIME	Seconds	0.1 ~ 10	0.5	
START CURRENT	% (of peak)	20 ~ 150	20	
START CURRENT TIME	Seconds	0 ~ 10	0	
UP-SLOPE TIME	Seconds	0 ~ 10	0	
PEAK WELDING CURRENT **	Amps	5 ~ 200	User defined *	
BASE CURRENT ***	Amps	5 ~ 200	50% **	
PULSE FREQUENCY	Hz	0.5 ~ 200	1	
PULSE WIDTH	%	10 ~ 90	50	
DOWN-SLOPE TIME	Seconds	0 ~ 20	1	
FINAL CURRENT	% (of peak)	20 ~ 80	20	
FINAL CURRENT TIME	Seconds	0 ~ 10	1	
POST-GAS TIME	Seconds	0 ~ 15	2	

* Some of the above settings are accessed and adjusted from the Extra Menu as shown in the top image.
 ** Depends on material thickness (30A per mm) eg. 3mm = 90A
 *** Set base current to 50% of your peak welding current

EVOLVE 200

TIG MIX DC - Quick Set-Up Guide

For DC TIG Mix welding, set up as below ensure you place the machine in TIG MIX, HF ON and 2T trigger mode.

This multi icon bar shows the operator a quick view of TIG options and settings. The icons shown will change depending on TIG background settings. Pressing the icons will allow entry to chosen setting.



TIG Mode MIX Mode Manual Mode 2T Mode Extra Menu Set Accordingly

Pressing the EXTRA icon will open up the advanced settings menu, from here you can select various additional TIG options as shown in the below table.

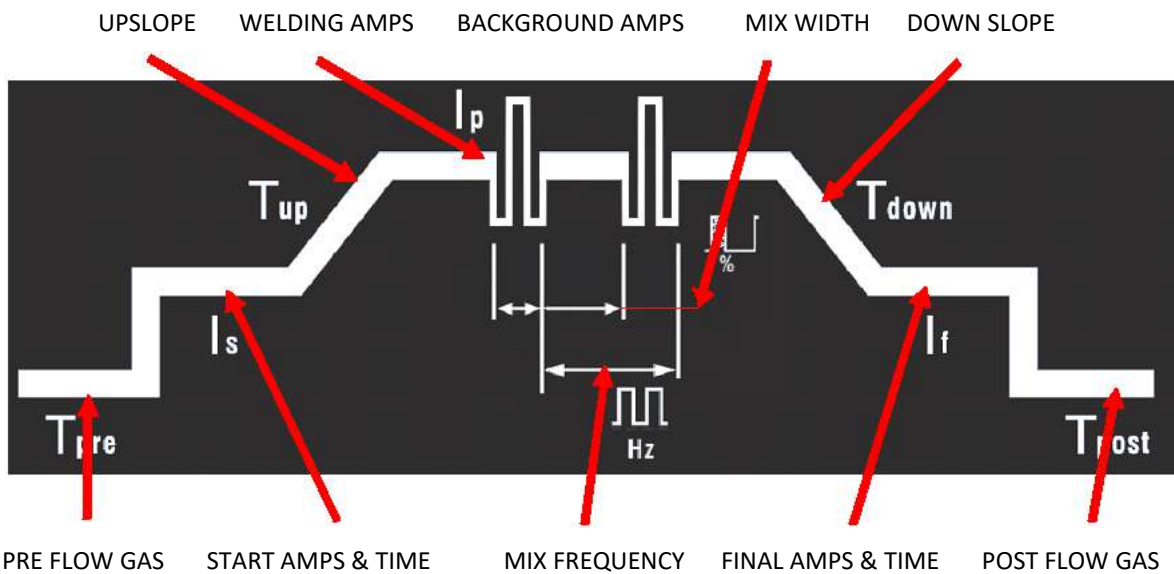

Rotating and pressing the left control dial will allow you to select, adjust and save TIG parameter settings. You can also use the touch screen to navigate through and adjust settings as recommended below.

Parameter	Units	Adjustable Range	Guide Setting	User Setting
Job/Material	---	---	---	
HF Switch *	N/A	On or Off	ON	
PRE-GAS TIME	Seconds	0.1 ~ 10	0.5	
START CURRENT	% (of peak)	20 ~ 150	20	
START CURRENT TIME	Seconds	0 ~ 10	0	
UP-SLOPE TIME	Seconds	0 ~ 10	0	
PEAK WELDING CURRENT **	Amps	5 ~ 200	User defined *	
MIX FREQUENCY	Hz	0.1 ~ 5	1	
MIX BALANCE	%	80 ~ 95	90	
MIX SOFTNESS ***	N/A	On or Off	OFF	
DOWN-SLOPE TIME	Seconds	0 ~ 20	1	
FINAL CURRENT	% (of peak)	20 ~ 80	20	
FINAL CURRENT TIME	Seconds	0 ~ 10	1	
POST-GAS TIME	Seconds	0 ~ 15	2	

* Some of the above settings are accessed and adjusted from the Extra Menu as shown in the top image.
 ** Depends on material thickness (30A per mm) eg. 3mm = 90A
 *** Set Mix softness to either OFF or ON depending on characteristic requirements

GUIDE TO TIG WELDING



Before starting any welding activity ensure that you have suitable eye protection and protective clothing. Also take the necessary steps to protect any persons within the welding area.

TIG torch body and components

The torch body holds the various welding consumables in place as shown and is covered by either a rigid phenolic or rubberised covering.

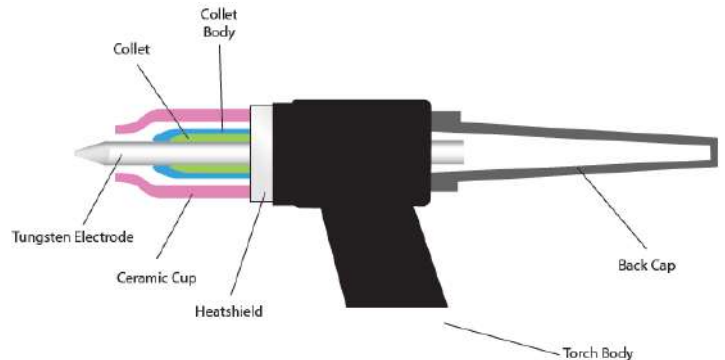

Collet body



The collet body screws into the torch body. It is replaceable and is changed to accommodate the different sizes tungsten's and their respective collets.

Collets



The welding electrode (tungsten) is held in the torch by the collet. The collet is usually made of copper or a copper alloy. The collet's grip on the electrode is secured when the torch back cap is tightened in place. Good electrical contact between the collet and tungsten electrode is essential for good welding current transfer.

Gas lens body



A gas lens is a device that can be used in place of the normal collet body. It screws into the torch body and is used to reduce turbulence in the flow of shield gas and produce a stiff column of undisturbed flow of shielding gas. A gas lens will allow the welder to move the nozzle further away from the joint allowing increased visibility of the arc.

A much larger diameter nozzle can be used which will produce a large blanket of shielding gas. This can be very useful in welding material like titanium. The gas lens will also enable the welder to reach joints with limited access such as inside corners.

Ceramic cups



Gas cups are made of various types of heat resistant materials in different shapes, diameters and lengths. The cups are either screwed onto the collet body or gas lens body or in some cases pushed in place. Cups can be made of ceramic, metal, metal-jacketed ceramic, glass or other materials. The ceramic type is quite easily broken so take care when putting the torch down.

Gas cups must be large enough to provide adequate shielding gas coverage to the weld pool and surrounding area. A cup of a given size will allow only a given amount of gas to flow before the gas flow becomes disturbed due to the speed of flow. Should this condition exist the size of cup should be increased to allow the flow speed to reduce and once again establish an effective regular shield.

Back cap

The back cap screws into the rear on the torch head and applies pressure to the back end of the collet which in turn forces up against the collet body, the resulting pressure holds the tungsten in place to ensure it does not move during the welding process.

Back caps are made from a rigid phenolic material and generally come in 3 sizes, short, medium and long.

GUIDE TO TIG WELDING



Before starting any welding activity ensure that you have suitable eye protection and protective clothing. Also take the necessary steps to protect any persons within the welding area.

TIG welding electrodes

TIG welding electrodes are a 'non consumable' as it is not melted into the weld pool and great care should be taken not to let the electrode contact the welding pool to avoid weld contamination. This would be referred to as tungsten inclusion and may result in weld failure.

Electrodes will often contain small quantities of metallic oxides which can offer the following benefits:

- Assist in arc starting
- Improve current carrying capacity of the electrode
- Reduce the risk of weld contamination
- Increase electrode life
- Increase arc stability

Oxides used are primarily zirconium, thorium, lanthanum or cerium. These are added usually 1% ~ 4%.



Tungsten Electrode Colour Chart - DC

Welding Mode	Tungsten Type	Colour
DC or AC/DC	Ceriated 2%	Grey
DC or AC/DC	Lanthanated 1%	Black
DC or AC/DC	Lanthanated 1.5%	Gold
DC or AC/DC	Lanthanated 2%	Blue
DC	Thoriated 1%	Yellow
DC	Thoriated 2%	Red

Tungsten Electrode Current Ranges

Tungsten Electrode Size	DC Current Amp
1.0mm	30 - 60
1.6mm	60 - 115
2.4mm	100 - 165
3.2mm	135 - 200
4.0mm	190 - 280
4.8mm	250 - 340

Tungsten electrode preparation - DC

When welding at low current the electrode can be ground to a point. At higher current a small flat on the end of the electrode is preferable as this helps with arc stability.

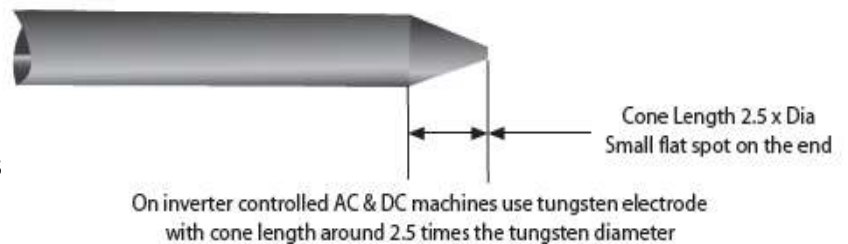

Electrode grinding

It is important when grinding the electrode to take all necessary precautions such as wearing eye protection and ensuring adequate protection against breathing in any grinding dust.

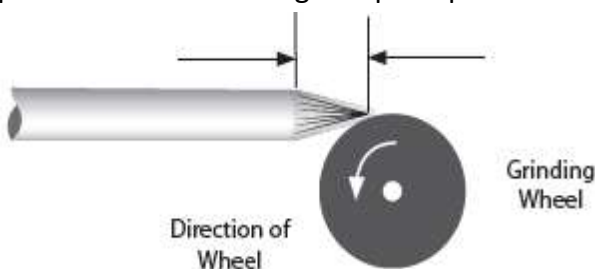

Tungsten electrodes should always be ground lengthwise (as shown left) and not in a radial operation. Electrodes ground in a radial operation tend to contribute to arc wander due to the arc transfer from the grinding pattern. Always use a grinder solely for grinding electrodes to avoid contamination.

GUIDE TO TIG WELDING



Before starting any welding activity ensure that you have suitable eye protection and protective clothing. Also take the necessary steps to protect any persons within the welding area.

TIG welding consumables

The consumables of the TIG welding process are filler wires and shield gas.

Filler wires

Filler wires come in many different material types and usually as cut lengths, unless some automated feeding is required where it will be in reel form. Filler wire is generally fed in by hand. Always consult the manufacturer's data and welding requirements.

Filler Wire Diameter	DC Current Range (Amps)
1.0mm	20 - 90
2.4mm	65 - 115
3.2mm	100 - 165
4.8mm	200 - 350

Filler Wire Selection Guide

Gases

Shielding gas is required when welding to keep the weld pool free of oxygen. Whether you are welding mild steel or stainless steel the most commonly used shielding gas used in TIG welding is argon, for more specialised applications an argon helium mix or pure helium may be used.

TIG welding - arc starting

The TIG process can use both non contact and contact methods to provide arc starting. Depending on the Jasic model, the options are indicated on a selector switch on the front control panel of the power source. The most common method of arc starting is 'HF' start. This term is often used for a variety of starting methods and covers many different types of start.

Arc starting - scratch start

This system is where the electrode is scratched along the work piece like striking a match. This is a basic way of turning any DC stick welder into a TIG welder without much work. It is not considered suitable for high integrity welding due to the fact that the tungsten can be melted on the work piece thereby contaminating the weld.

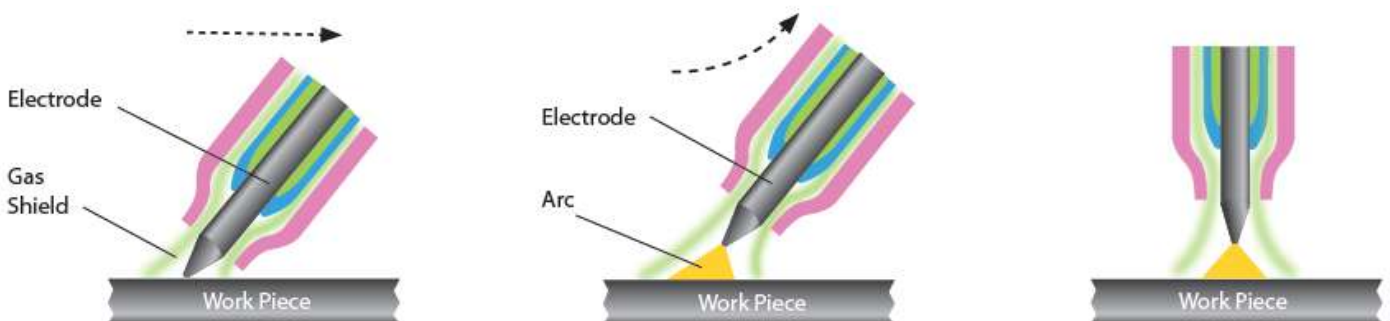

The main challenge with scratch start TIG welding is keeping your electrode clean. While a quick strike with the electrode on the metal is essential and then not lifting it more than 3mm away to create the arc will help, you also need to ensure your metal is completely clean.

GUIDE TO TIG WELDING



Before starting any welding activity ensure that you have suitable eye protection and protective clothing. Also take the necessary steps to protect any persons within the welding area.

Lift TIG (lift arc)

Not to be confused with scratch start, this arc starting method allows the tungsten to be in direct contact with the work piece first but with minimal current so as not to leave a tungsten deposit when the tungsten is lifted away from the base material and an arc is established.

With lift TIG, the open circuit voltage (OCV) of the welder folds back to a very low voltage output when the unit senses it has made continuity with the work piece. Once the torch is lifted the unit increases output as the tungsten leaves the surface. This creates little contamination and preserves the point on the tungsten although this is still not a 100% clean process. The tungsten still can get contaminated but lift TIG is still a much better option than scratch starting, for mild and stainless steel although these methods of arc starting are not a good option when welding aluminium.

The Jasic Evolve 200 offers Lift TIG mode utilising the TIG torch switch operation mode which starts the process with the internal gas valve opening to start the gas flow first.

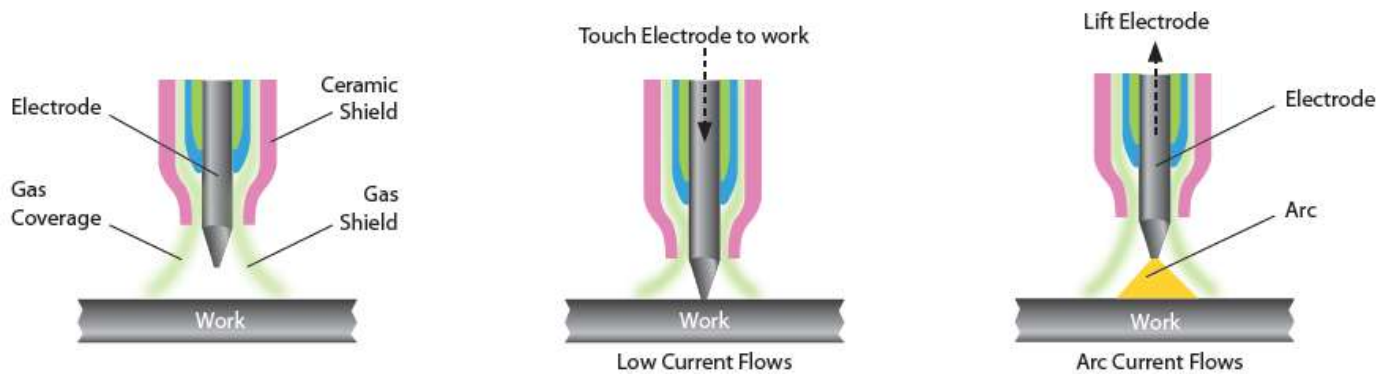

Set the TIG welding current and other TIG welding parameters by using the control dial. (see page 14 onwards for control panel details)

LIFT TIG process

Press the TIG torch switch, then touch the tungsten electrode to the work piece for less than 2 seconds and then lift away to 2mm - 4mm from the work piece and the welding arc is then established.

Once welding is complete release the torch trigger to disengage the welding arc but ensure you leave the torch in place to shield the weld with gas for a few seconds and then turn off the gas at the valve on the torch head.

PLEASE NOTE:

- When starting the arc if the short-circuit time exceeds 2 seconds the welder turns off the output current, lift the welding torch tungsten away from the work piece and restart the process as above to start the arc again.
- During welding, if there is short circuit between tungsten electrode and the work piece, the welder will immediately reduce the output current; if the short circuit exceeds 1 second, the welder will turn off the output current. If this happens, the arc will need to be restarted as above and the welding torch needs to be lifted to start the arc again.

GUIDE TO DC TIG WELDING



Before starting any welding activity ensure that you have suitable eye protection and protective clothing. Also take the necessary steps to protect any persons within the welding area.

Manual DC TIG Welding Amperage Guide- Mild Steel and Stainless Steel

Base Metal Thickness mm	Base Metal Thickness Inch (")	Tungsten Electrode Diameter	Output Polarity	Filler Wire Diameter (If Required)	Argon Gas Flow Rate (litres/min)	Joint Types	Amperage Range
1.6mm	1/16"	1.6mm	DC	1.6mm	5 - 8	Butt	50 - 80
1.6mm	1/16"	1.6mm	DC	1.6mm	5 - 8	Corner	50 - 80
1.6mm	1/16"	1.6mm	DC	1.6mm	5 - 8	Fillet	60 - 90
1.6mm	1/16"	1.6mm	DC	1.6mm	5 - 8	Lap	60 - 90
2.4mm	3/32"	1.6/2.4mm	DC	1.6/2.4mm	5 - 9	Butt	80 - 110
2.4mm	3/32"	1.6/2.4mm	DC	1.6/2.4mm	5 - 9	Corner	80 - 110
2.4mm	3/32"	1.6/2.4mm	DC	1.6/2.4mm	5 - 9	Fillet	90 - 120
2.4mm	3/32"	1.6/2.4mm	DC	1.6/2.4mm	5 - 9	Lap	90 - 120
3.2mm	1/8"	2.4mm	DC	2.4mm	5 - 10	Butt	80 - 120
3.2mm	1/8"	2.4mm	DC	2.4mm	5 - 10	Corner	90 - 120
3.2mm	1/8"	2.4mm	DC	2.4mm	5 - 10	Fillet	100 - 140
3.2mm	1/8"	2.4mm	DC	2.4mm	5 - 10	Lap	100 - 140
4.8mm	3/16"	2.4mm	DC	2.4mm	6 - 11	Butt	120 - 200
4.8mm	3/16"	2.4mm	DC	2.4mm	6 - 11	Corner	150 - 200
4.8mm	3/16"	2.4mm	DC	2.4mm	6 - 11	Fillet	170 - 220
4.8mm	3/16"	2.4mm	DC	2.4mm	6 - 11	Lap	150 - 200
6.4mm	1/4"	2.4mm	DC	3.2mm	7 - 12	Butt	225 - 300
6.4mm	1/4"	2.4mm	DC	3.2mm	7 - 12	Corner	250 - 300
6.4mm	1/4"	2.4mm	DC	3.2mm	7 - 12	Fillet	250 - 320
6.4mm	1/4"	2.4mm	DC	3.2mm	7 - 12	Lap	250 - 320
9.5mm	3/8"	3.2mm	DC	3.2mm	7 - 12	Butt	250 - 360
9.5mm	3/8"	3.2mm	DC	3.2mm	7 - 12	Corner	260 - 360
9.5mm	3/8"	3.2mm	DC	3.2mm	7 - 12	Fillet	270 - 380
9.5mm	3/8"	3.2mm	DC	3.2mm	7 - 12	Lap	230 - 380
12.7mm	1/2"	3.2/4mm	DC	3.2mm	8 - 13	Butt	300 - 400
12.7mm	1/2"	3.2/4mm	DC	3.2mm	8 - 13	Corner	320 - 420
12.7mm	1/2"	3.2/4mm	DC	3.2mm	8 - 13	Fillet	320 - 420
12.7mm	1/2"	3.2/4mm	DC	3.2mm	8 - 13	Lap	320 - 420

Please Note:

- All above guide settings are approximate and will vary depending on application, prep, passes and type of welding equipment used.
- The welds would need to be tested to ensure they comply to your welding specifications.

TIG TORCH SPARE PARTS LIST



TIG Welding Torch Air Cooled - Model TIG-110

Rating 200A DC, 150A AC @ 60% Duty Cycle EN60974-7 • 0.5mm to 4.0mm Electrodes



Consumables

Model: T26

2 PIN Torch plug Pt No - JG071008-1

Main Consumables

Code	Description	Pack Qty
1	WP26 Rigid Torch Body	1
2	WP26F Flexible Torch Body	1
3	WP26FV Flexible Torch Body c/w Argon Valve	1
4	WP26V Torch Body c/w Argon Valve	1
5	57Y04 Short Back Cap	1
6	300M Medium Back Cap	1
7	57Y02 Long Back Cap	1
8	98W18 Back Cap 'O' Ring	10

Collets

Code	Description	Pack Qty
9	10N21 Standard .020" (0.5mm)	5
	10N22 Standard .040" (1.0mm)	5
	10N23 Standard 1/16" (1.6mm)	5
	10N26 Standard 5/64" (2.0mm)	5
	10N24 Standard 3/32" (2.4mm)	5
	10N25 Standard 1/8" (3.2mm)	5
	54N20 Standard 5/32" (4.0mm)	5
10	10N215 Stubby .020" (0.5mm)	5
	10N225 Stubby .040" (1.0mm)	5
	10N235 Stubby 1/16" (1.6mm)	5
	10N245 Stubby 3/32" (2.4mm)	5
	10N255 Stubby 1/8" (3.2mm)	5

Collet Bodies

Code	Description	Pack Qty
11	10N29 Standard .020" (0.5mm)	5
	10N30 Standard .040" (1.0mm)	5
	10N31 Standard 1/16" (1.6mm)	5
	10N31M Standard 5/64" (2.0mm)	5
	10N32 Standard 3/32" (2.4mm)	5
	10N28 Standard 1/8" (3.2mm)	5
	406488 Standard 5/32" (4.0mm)	5
12	17CB20 Stubby .020"-1/8" (0.5 - 3.2mm)	5

Gas Lens Bodies

Code	Description	Pack Qty
13	45V29 Standard .020" (0.5mm)	1
	45V24 Standard .040" (1.0mm)	1
	45V25 Standard 1/16" (1.6mm)	1
	45V25M Standard 5/64" (2.0mm)	1
	45V26 Standard 3/32" (2.4mm)	1
	45V27 Standard 1/8" (3.2mm)	1
	45V28 Standard 5/32" (4.0mm)	1
14	45V0204 Large Dia .020"-0.40" (0.5 - 1.0mm)	1
	45V116 Large Dia 1/16" (1.6mm)	1
	45V64 Large Dia 3/32" (2.4mm)	1
	995795 Large Dia 1/8" (3.2mm)	1
	45V63 Large Dia 5/32" (4.0mm)	1

Ceramic Cups

Code	Description	Pack Qty
15	10N50 Standard Cup 1/4" Bore	10
	10N49 Standard Cup 5/16" Bore	10
	10N48 Standard Cup 3/8" Bore	10
	10N47 Standard Cup 7/16" Bore	10
	10N46 Standard Cup 1/2" Bore	10
	10N45 Standard Cup 5/8" Bore	10
	10N44 Standard Cup 3/4" Bore	10

Ceramic Cups (continued)

Code	Description	Pack Qty
16	10N50L Long Cup 1/4" Bore	10
	10N49L Long Cup 5/16" Bore	10
	10N48L Long Cup 3/8" Bore	10
	10N47L Long Cup 7/16" Bore	10

Gas Lens Cups

Code	Description	Pack Qty
17	54N18 Standard Cup 1/4" Bore	10
	54N17 Standard Cup 5/16" Bore	10
	54N16 Standard Cup 3/8" Bore	10
	54N15 Standard Cup 7/16" Bore	10
	54N14 Standard Cup 1/2" Bore	10
	54N19 Standard Cup 1 1/16" Bore	10
18	54N17L Long Cup 5/16" Bore	10
	54N16L Long Cup 3/8" Bore	10
	54N15L Long Cup 7/16" Bore	10
	54N14L Long Cup 1/2" Bore	10
19	57N75 Large Dia Cup 3/8" Bore	5
	57N74 Large Dia Cup 1/2" Bore	5
	53N88 Large Dia Cup 5/8" Bore	5
	53N87 Large Dia Cup 3/4" Bore	5

Ceramic Cups for use with item 12

Code	Description	Pack Qty
20	13N08 Standard Cup 1/4" Bore	10
	13N09 Standard Cup 5/16" Bore	10
	13N10 Standard Cup 3/8" Bore	10
	13N11 Standard Cup 7/16" Bore	10
	13N12 Standard Cup 1/2" Bore	10
	13N13 Standard Cup 5/8" Bore	10
21	796F70 Long Cup 3/16" Bore	10
	796F71 Long Cup 1/4" Bore	10
	796F72 Long Cup 5/16" Bore	10
	796F73 Long Cup 3/8" Bore	10
22	796F74 X - Long Cup 3/16" Bore	10
	796F75 X - Long Cup 1/4" Bore	10
	796F76 X - Long Cup 5/16" Bore	10
	796F77 X - Long Cup 3/8" Bore	10

Secondary Consumables

Code	Description	Pack Qty
23	SP9110 LH & RH Handle Shell	1
	SP9111 Handle Screw	1
25	SP9120 Single Button Switch	1
	SP9121 2 Button Switch	1
	SP9122 5K Potentiometer Switch	1
	SP9123 10K Potentiometer Switch	1
	SP9128 47K Potentiometer Switch	1
	SP9129 4 Button Switch	1
26	SP9114 Handle Ball Joint	1
27	SP9117 Leather Cover 800mm	1
28	SP9119 Cable Cover Joint (not illustrated)	1
29	18CG Standard Heat Shield	1
30	54N01 Gas Lens Heat Shield	1
31	54N63 Large Gas Lens Insulator	1
32	VS-1 Valve Stem WP26V & WP26FV	1
33	46V28 Mono Power Cable Assy 12.5ft - 3/8" Bsp	1
	46V30 Mono Power Cable Assy 25ft - 3/8" Bsp	1
34	46V28-2D 2 Piece Power Cable Assy 12.5ft - Dinse / 3/8" Bsp	1
	46V30-2D 2 Piece Power Cable Assy 25ft - Dinse / 3/8" Bsp	1
35	0315071 Insulation Boot	5
36	6091 Neoprene Protective Cover	1m
37	SP9126 4m Switch Cable c/w 5 Pin Receptacle	1
	SP9127 8m Switch Cable c/w 5 Pin Receptacle	1

PLEASE NOTE: Check the torch supplied with your package to ensure it matches the above TIG torch details.

TIG WELDING TROUBLESHOOTING



Before starting any welding activity ensure that you have suitable eye protection and protective clothing. Also take the necessary steps to protect any persons within the welding area.

TIG welding defects and prevention methods

<u>Defect</u>	<u>Possible cause</u>	<u>Action</u>
Excessive tungsten use	Set up for DCEP.	Change to DCEN.
	Insufficient shield gas flow.	Check for gas restriction and correct flow rates. Check for drafts in the weld area.
	Electrode size too small.	Select correct size.
	Electrode contamination during cooling time.	Extend post flow gas time.
Porosity/weld contamination	Loose torch or hose fitting.	Check and tighten all fitting.
	Inadequate shield gas flow.	Adjust flow rate - normally 8 - 12l/m.
	Incorrect shield gas.	Use correct shield gas.
	Gas hose damaged.	Check and repair any damaged hoses.
	Base material contaminated.	Clean material properly.
	Incorrect filler material.	Check correct filler wire for grade of use.
No operation when torch switch is operated	Torch switch or cable faulty.	Check the torch switch continuity and repair or replace as required.
	ON/OFF switch turned off.	Check position of ON/OFF switch.
	Mains fuses blown.	Check fuses and replace as required.
	Fault inside the machine.	Call for a repair technician.
Low output current	Loose or defective work clamp.	Tighten/replace clamp.
	Loose cable plug.	Check and tighten all plugs.
	Power source faulty.	Call a repair technician.
High frequency will not strike the arc	Weld/power cable open circuit.	Check all cables and connections for continuity, especially the torch cables.
	No shield gas flowing.	Check cylinder contents, regulator and valves, also check the power source.
Unstable arc when welding in DC	Tungsten contaminated.	Break off contaminated end and regrind the tungsten.
	Arc length incorrect.	Arc length should be between 3mm - 6mm depending on application.
	Material contaminated.	Clean all base and filler material.
	Electrode connected to the wrong polarity.	Reconnect to correct polarity.
Arc is difficult to start	Incorrect tungsten type.	Check and fit correct tungsten.
	Incorrect shield gas.	Use argon shield gas.

TIG WELDING TROUBLESHOOTING



Before starting any welding activity ensure that you have suitable eye protection and protective clothing. Also take the necessary steps to protect any persons within the welding area.

TIG welding defects and prevention methods

<u>Defect</u>	<u>Possible cause</u>	<u>Action</u>
Excessive bead build up, poor penetration or poor fusion at the edges of the weld.	Weld current too low.	Increase the welding amperage. Poor material prep.
Weld bead flat and too wide or undercut at the weld edge or burning through.	Weld current too high.	Decrease the welding amperage.
Weld bead too small or insufficient penetration.	Welding travel speed too fast.	Reduce your welding travel speed.
Weld bead too wide or excessive bead build up.	Welding travel speed too slow.	Increase your welding travel speed.
Uneven leg length in fillet joint.	Wrong placement of filler rod.	Re-position filler rod.
Tungsten melts or oxidises when welding arc is established.	TIG torch lead connected to +	Connect torch to - polarity.
	Little or no gas flow to weld pool.	Check gas apparatus as well as torch and hoses for breaks or restrictions.
	Gas cylinder or hoses contain impurities.	Change gas cylinder and blow out torch and gas hoses.
	The tungsten is too small for the weld current.	Increase the size of the tungsten.
	TIG/MMA selector set to MMA.	Ensure you have the power source set to TIG function.

TIG TORCH TROUBLESHOOTING

TIG welding defects and prevention methods

The TIG torch used for lift TIG welding comprises of several items which ensure current flow and arc shielding from the atmosphere.

Regular maintenance of the welding torch is one of the most important measures to ensure its normal operation and extend lifespan.

In order to ensure normal maintenance, the wearing parts of the torch should have spares, including the electrode holder, nozzle, sealing ring, insulating washer, etc.

Common faults of the welding torch include overheating, gas leakage, water leakage, poor gas protection, electric leakage, nozzle burn out, and cracking.

The causes of these faults and troubleshooting methods are as shown in the following table.

Symptom	Reasons	Troubleshooting
The welding torch is overheating.	The welding torch capacity is too small.	Replace with a welding torch with large capacity.
	The collet fails to clamp the tungsten electrode.	Replace the collet or back cap.
Gas leakage.	The sealing ring is worn.	Replace the sealing ring.
	The gas connection thread is loose.	Tighten the gas connections.
	The gas inlet pipe joint is damaged or not fastened.	Cut off the damaged joint, reconnect and tighten the replaced gas inlet pipe or wrap up the damaged area.
	The gas inlet pipe has been damaged by heat or aging.	Replace the gas inlet pipe.
Operator receiving a shock from the torch.	The torch head is wet due to leakage or other reasons.	Find the cause of water leakage, and fully dry the torch head.
	The torch head is damaged or the live metal part is exposed.	Replace the torch head or wrap the exposed electrified metal part with adhesive tape.
Poor gas flow or porosity in the weld.	The welding torch is leaking.	Locate the leakage.
	The nozzle diameter is too small.	Replace with a nozzle of larger diameter.
	The nozzle is damaged or cracked.	Replace with a new nozzle.
	The gas circuit in the welding torch is blocked.	Blow the circuit with compressed air to clear the blockage.
	The gas screen has been damaged or lost during disassembly and assembly.	Replace with a new gas screen.
	The argon gas is impure.	Replace with standard argon gas.
Arc started between the collet/collet holder or the tungsten electrode/torch head.	The gas flow is too large or small.	Adjust the gas flow properly.
	The collet and tungsten electrode have poor contact, or arc is started when the tungsten electrode contacts the base metal.	Replace the collet or repair.
	The collet and welding torch have poor contact.	Connect the collet and welding torch properly.

OPERATION MIG



Before starting any welding activity ensure that you have suitable eye protection and protective clothing. Also take the necessary steps to protect any persons within the welding area.

MIG/MAG welding

- Insert the welding torch (A) into the “Euro connector for torch in MIG” output socket on the front panel of the machine and tighten it into position.
- Insert the work return lead cable plug (B) into the “-” output terminal of the welding machine and tighten by rotating it clockwise.
- Ensure that the link (G) the torch polarity connection link is in the vertical position and connected to the “+” terminal, this ensure that’s the MIG torch polarity is positive (+).
- Install the welding wire on the spindle adapter (C).
- Connect the cylinder equipped with the gas regulator to the gas inlet on the back panel of the machine with a gas hose.
- Ensure that the wire groove size of the fitted drive roll matches the contact tip (fitted to the MIG torch) and the welding wire size fitted (D).
- Release the pressure arm of the wire feeder to thread the wire through the guide tube (E) and into the drive roll groove and then adjust the pressure arm, ensuring no slipping of the wire can occur (too much pressure will lead to wire distortion which will affect wire feed performance).
- Turn the machine ON (F) as shown right.
- If the MIG torch trigger is pressed, MIG welding mode will automatically be selected or using the user display, place the ‘welding mode’ function into MIG mode position (see page 22).
- ‘Inch’ the welding wire through the MIG torch and out through the torch contact tip (see page 65). You are now ready to start MIG welding.

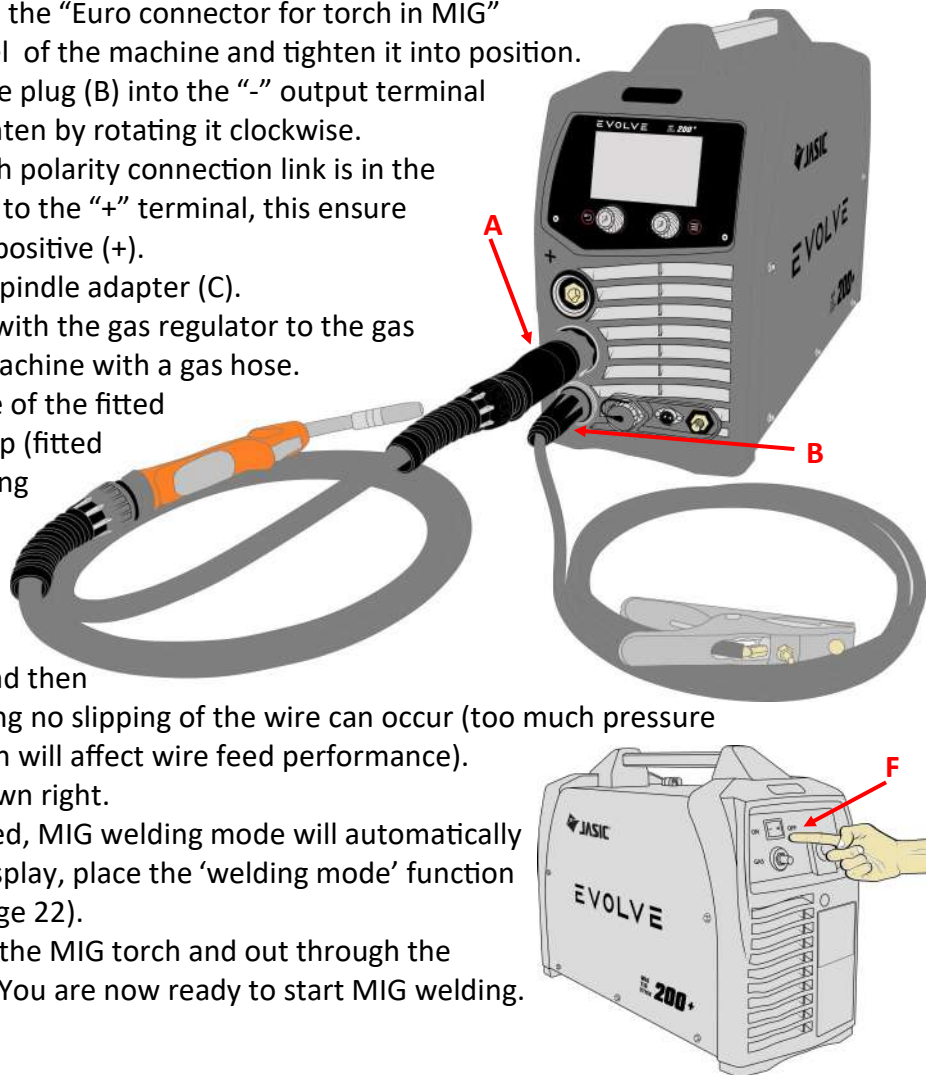

Gasless self shielded MIG welding

MIG welding with gasless wire, the MIG torch and work polarity are required to be reversed, the MIG torch is now negative ‘-’ and the work return lead positive ‘+’.

Setup is as above along with the following:

- Insert the work return lead cable plug (B) into the “-” output terminal of the welding machine and tighten by rotating it clockwise.
- Ensure that the link (G) the torch polarity connection link is in the horizontal position and connected to the “-” negative terminal, this means that the MIG torch polarity is now negative.
- Ensure that you have disconnected the gas hose from the machine and turned OFF the gas supply at the gas cylinder.

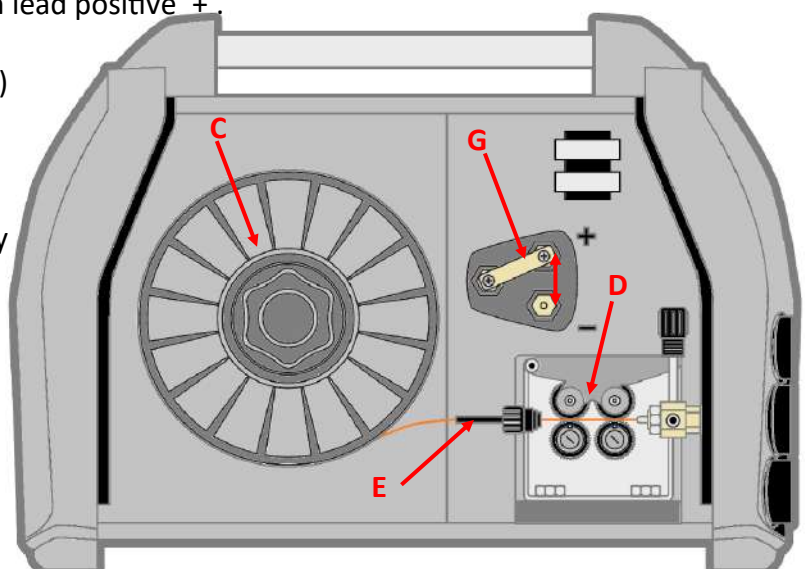

OPERATION MIG



Before starting any welding activity ensure that you have suitable eye protection and protective clothing. Also take the necessary steps to protect any persons within the welding area.

Display Area Top Bar - MIG Mode

This multi icon bar shows the operator a quick view of MIG options and settings. The icons shown will change depending on MIG background settings. Pressing the icons will allow entry to chosen setting.

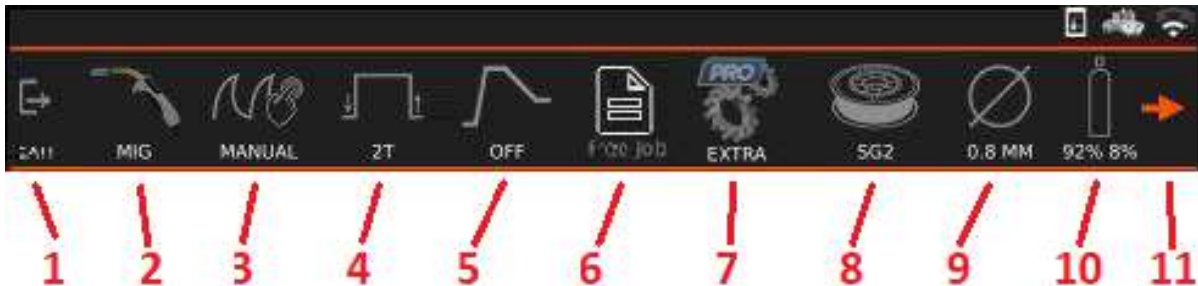

1. Pressing the **EXIT** button on the top bar menu will take you back to the MIG welding screen.



2. **MIG Mode:** The selected welding process icon and screen button.



3. **MIG Manual, Synergic, Pulse or Double Pulse selection button.**

Pushing the button will allow you to change from manual MIG to Synergic MIG and Pulse MIG welding modes and upon selecting your chosen mode, the corresponding indicator will be shown in the top menu bar.

- Manual: Selects standard MIG welding mode.
- Synergic TIG software will calculate the optimal settings based on the operators selected wire, gas and material thickness.
- Pulse MIG: MIG welding with pulse that alternates between the peak and the base current.
- Double Pulse: MIG welding with double pulse that alternates between the peak and the base current.



4. **MIG Torch Trigger mode selection icon and button.**

Pushing this icon button allows access to change the MIG torch trigger mode from 2T, 4T and spot welding mode, when chosen the corresponding indicator will be shown in the top menu bar.

- 2T (2 touch): You need to press and hold the button down on your MIG torch to weld, releasing will stop welding.
- 4T (4 touch/latch): You only need to press the button to initiate welding, release to continue welding and to stop welding, press and release again and welding will stop.
- Spot: Spot welding mode give consecutive, evenly timed welds that offers perfectly even tacks and small welds.



See page 86 for further details on trigger mode instructions.

5. **Hot Start: (Synergic and Pulse Mode Only)**

Pushing the button allows access to selecting hot start mode, which offers an initial burst of current, improving initial the arc ignition.

- Hot Start Off
- Hot Start On

Please Note:

Depending on machine software version installed, the icon order and selection may differ.



OPERATION MIG



Before starting any welding activity ensure that you have suitable eye protection and protective clothing. Also take the necessary steps to protect any persons within the welding area.

Display Area Top Bar - MIG Mode (continued)

This multi icon bar shows the operator a quick view of MIG options and settings. The icons shown will change depending on MIG background settings. Pressing the icons will allow entry to chosen setting.

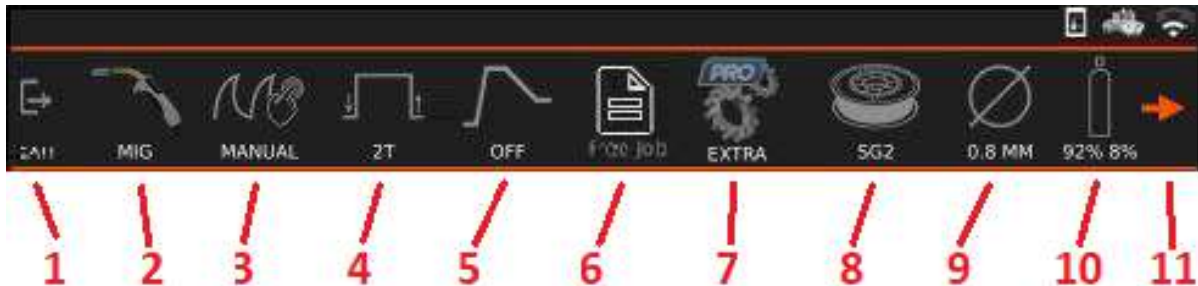

6. Memory function:



The Evolve 200 is capable of storing 100 Jobs in it's memory and the jobs menu can be accessed from pressing the job menu icon as shown left. If a Job No is selected, the reference number of the Job is showing in the icon display. If 'Free' is displayed, this indicates that no job is selected.

- Load job
- Save Current Settings as a Job
- Reset Job to original values
- Return to Free Job

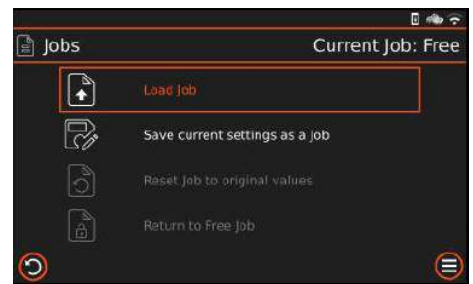

8. Material type: (Manual, Synergic and Pulse Mode)

Pushing the button allows access to selecting the welding wire material type set up in the machine.

- 0.8
- 0.9
- 1.0
- 1.2

Please Note:

Depending on the material selected, wire size options may change.



9. Welding Wire Size: (Manual, Synergic and Pulse Mode)

Pushing the button allows access to selecting the MIG welding wire size set up in the machine.

- SG2: Mild Steel
- CRNI: Stainless Steel
- ALMG5: Aluminium Magnesium (AM5356)
- ALSI5: Aluminium Silicon (AM4043)
- CUSI3: Silicon Bronze



10. MIG welding gas: (Manual, Synergic and Pulse Mode)

Pressing the gas selection icon button allows the operator to change the MIG welding gas, the chosen gas corresponding icon will be shown in the top menu bar, as shown right.

Please Note:

Depending on the material selected, gas selection options may change.

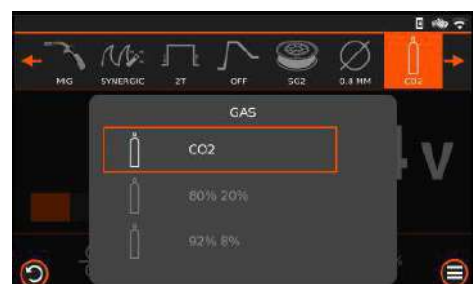

OPERATION MIG



Before starting any welding activity ensure that you have suitable eye protection and protective clothing. Also take the necessary steps to protect any persons within the welding area.

Display Area Top Bar - MIG Mode (continued)

The icons shown will change depending on MIG background settings. Pressing the icons will allow entry to chosen setting.



7. Extra function:

Pressing the EXTRA icon will enter the advanced settings menu, from here you can select various additional MIG options as shown right. Rotating and pressing the left control dial will allow you to select, adjust and save parameter settings.

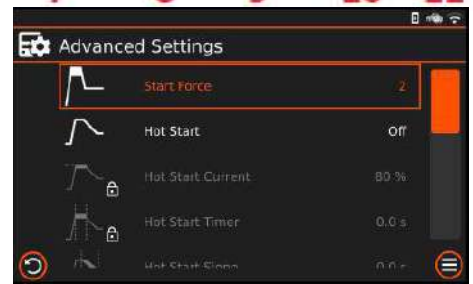

Please Note:

The advanced options listed will depend on a number of factors, for example, if you have either MIG Synergic, Pulse or double pulse, Spot mode selected you would see additional options listed than if you had MIG manual selected. You may also note that some functions are locked, this is because some settings will only adjust in manual mode rather than in Synergic mode. MIG Advanced settings list, values and description are as shown below.

Setting	Value	Description
PreGas Timer	0.1 - 10s	Setting for how long your shielding gas flows before arc ignition.
Hot Start	On/Off	Setting to turn hot start on or off.
Hot Start Current	20 - 150%	Set the starting current when on initial arc ignition.
Hot Start Timer	0 - 10s	Setting for how long start current lasts for.
Hot Start Slope	0 - 10s	Slope up current time before reaching the peak welding current.
Inductance Correction	± 10	Sets how fast the current rises to reach welding current to enhance your arc characteristics when welding.
Burnback	± 10	Set how far the wire will burn back once the MIG torch trigger has been released.
Spot Timer	0.5 - 25s	Set the length of time to run the SPOT function.
Double Pulse Mode	Sta/Adv	Standard or Advanced settings adjustments for double pulse.
Double Pulse Frequency	0.5 - 1kHz	Set the number of pulses per second.
Double Pulse Balance	25 - 75%	Set the percentage of each pulse spent in peak current.
Double Pulse Low Current	20 - 80%	Set the base (lower) current value when in pulse mode.
Stop Slope	0 - 20s	Slope down current time before reaching final current.
Stop Current	20 - 80%	Setting for final current.
Stop Timer	0 - 10s	Setting for how long final current lasts for.
Postgas Timer	0.1 - 3s	Sets the period of time for the shielding gas to flow once arc ignition stops.
Restore Default Settings		Restores welding parameters to factory setting.

Please Note:

Depending on machine location and firmware installed, the icon, order and option shown may differ.

OPERATION MIG



Before starting any welding activity ensure that you have suitable eye protection and protective clothing. Also take the necessary steps to protect any persons within the welding area.

MIG - Advanced settings menu (continued)

Please Note:

The advanced options listed will depend on a number of factors, for example, if in either MIG synergic, pulse or double pulse mode with 'spot' mode selected, you would see additional options listed than if you were in manual MIG mode.

You may also note that some functions are locked (shown with a padlock symbol), this is because some options can only be adjusted in manual mode rather than in Synergic mode.

The MIG Advanced settings options list, values and description

are as shown below, all options possible are listed regardless of what MIG mode or options is selected.

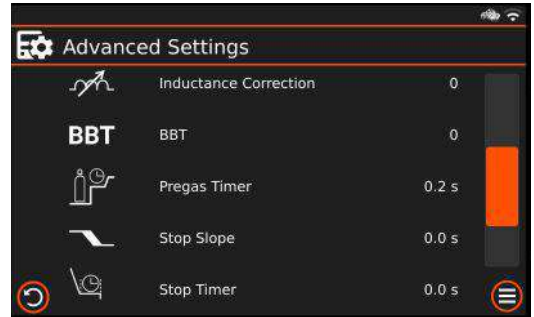

Pregas Timer:

Select the pre flow time setting function by rotating the left control dial until pre gas is highlighted, pressing and then rotating the left dial will allow you to adjust and set the pre flow time in seconds.

Hot Start: (Synergic and Pulse modes only)

When you select this setting, you can either select hot start on or off. Pressing and the rotating the left dial will allow you to select on or off mode.

Hot Start Current: (Synergic and Pulse modes only)

Select the initial current setting function by rotating the left control dial until start current is highlighted, pressing and then rotating the left dial will allow you to adjust and set the initial current.

Hot Start Timer: (Synergic and Pulse modes only)

Select the start timer setting function by rotating the left control dial until start timer is highlighted, pressing and then rotating the left dial will allow you to adjust and initial current time in seconds.

Hot Start Slope: (Synergic and Pulse modes only)

Select the upslope time setting function by rotating the left control dial until start slope is highlighted, pressing and the rotating the left dial will allow you adjust the slope up time in seconds.

Inductance:

Select the inductance setting function by rotating the left control dial until inductance is highlighted, pressing and the rotating the left dial will allow you adjust the inductance setting.

Factory setting being 0 and adjustable from -10 to +10.

Burnback Time:

Select the burnback setting function by rotating the left control dial until burnback time is highlighted, pressing and the rotating the left dial will allow you adjust the burnback setting.

Factory setting being 0 and adjustable from -10 to +10.

Spot Time: (Spot mode only)

Select the spot timer setting function by rotating the left control dial until spot timer is highlighted, pressing and the rotating the left dial will allow you adjust to adjust the spot time in seconds from 0.5 - 25 seconds

Double Pulse Mode: (Double pulse mode only)

Select double pulse mode in the extra's menu by rotating the left control dial until double pulse mode is highlighted, pressing and the rotating the left dial will allow you to select either standard or advanced double pulse mode.

OPERATION MIG



Before starting any welding activity ensure that you have suitable eye protection and protective clothing. Also take the necessary steps to protect any persons within the welding area.

MIG - Advanced settings menu (continued)

Please Note:

The advanced options listed will depend on a number of factors, for example, if in either MIG synergic, pulse or double pulse mode with 'spot' mode selected, you would see additional options listed than if you were in manual MIG mode.

You may also note that some functions are locked (shown with a padlock symbol), this is because some options can only be adjusted in manual mode rather than in Synergic mode.

The MIG Advanced settings options list, values and description are as shown below, all options possible are listed regardless of what MIG mode or options is selected.

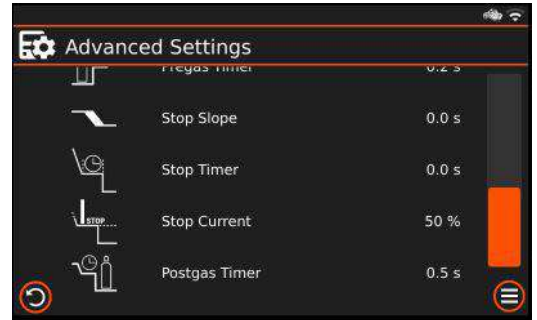

Double Pulse Frequency: (standard or advanced)

When in double pulse mode, Select double pulse frequency setting function by rotating the left control dial until double pulse frequency is highlighted, pressing and the rotating the left dial will allow you adjust double pulse frequency in Hz from 0.5 to 5Hz.

Double Pulse Balance: (advanced only)

When in double pulse mode, Select double pulse balance setting function by rotating the left control dial until double pulse balance is highlighted, pressing and the rotating the left dial will allow you adjust double pulse balance in percentage from 10 to 90%.

Pulse Low Current: (advanced only)

When in double pulse mode, Select double pulse balance setting function by rotating the left control dial until double pulse balance is highlighted, pressing and the rotating the left dial will allow you adjust double pulse balance in percentage from 10 to 90%.

Stop Slope: (Synergic and Pulse modes only)

Select the stop slope time setting function by rotating the left control dial until stop slope is highlighted, pressing and the rotating the left dial will allow you to adjust the downslope time in seconds.

Stop Timer: (Synergic and Pulse modes only)

Select the stop timer setting function by rotating the left control dial until start timer is highlighted, pressing and then rotating the left dial will allow you to adjust and final current time.

Stop Current: (Synergic and Pulse modes only)

Select the initial current setting function by rotating the left control dial until start current is highlighted, pressing and then rotating the left dial will allow you to adjust and set the final current.

Post Gas Timer:

Select the post flow time setting function by pressing the adjustment control knob until post gas is highlighted and then rotating the left dial will allow you to adjust post flow gas time in seconds.

GLICK Level: (4T Synergic and Pulse modes only)

When in MIG 4T mode, Select Glick level setting function by rotating the left control dial until Glick level is highlighted, pressing and the rotating the left dial will allow you to turn Glick level on/off.

Restore Default Settings:

Selecting Parameter reset to factory settings is done by rotating the left control dial until restore default settings is highlighted, pressing and then rotating the left dial will restore all MIG parameters to default factory settings.

OPERATION MIG MANUAL



Before starting any welding activity ensure that you have suitable eye protection and protective clothing. Also take the necessary steps to protect any persons within the welding area.

MIG/MAG Standard Welding Mode

MIG - Metal Inert Gas Welding, MAG - Metal Active Gas Welding, GMAW - Gas Metal Arc Welding

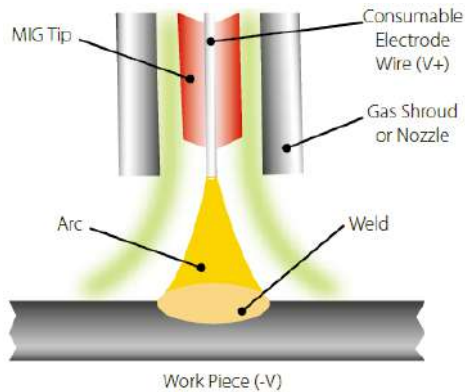

MIG welding was developed to help meet production demands of the war and post war economy which is an arc welding process in which a continuous solid wire electrode is fed through a MIG welding gun and into the weld pool, joining the two base materials together.

A shielding gas is also sent through the MIG welding gun and protects the weld pool from contamination which also enhances the arc.

Connect the MIG torch connector (A) to the Euro outlet on the front panel.

Connect the work return lead to '-' (B) dinse connector.

Ensure that a suitable shielding gas supply is connected.

Switch the power switch via the rear panel to "ON" the machine will power up with the control panel lighting up and the cooling fans will briefly start running.

Open the gas valve of the cylinder and adjust the gas regulator or flowmeter to obtain the desired flow rate.

Depending on your exact MIG welding requirements you can follow the below instructions to obtain your optimum MIG setup.

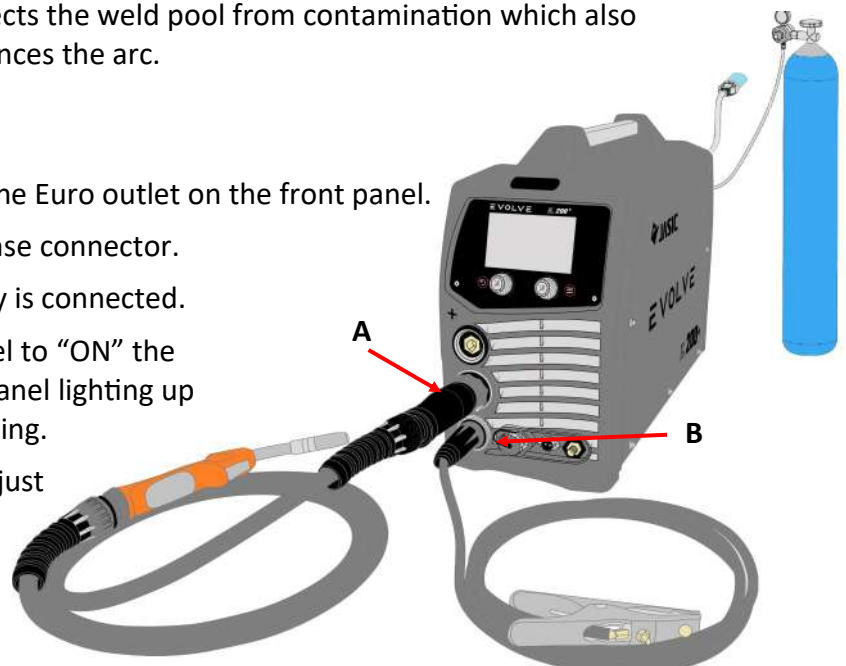

Standard Welding Mode:

Once the machine has been setup for MIG (see above and also page 59) you will be in a position to setup the control panel for your MIG welding tasks.

The control panel image right is an example of the machine set up in standard (manual) MIG mode and the following few pages will explain the setup steps of operation.

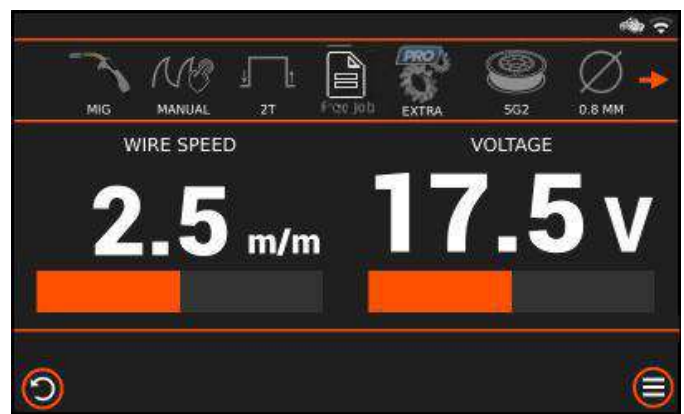

Wire Inch

Wire Inch is a feature that allows you to push the wire through the MIG torch without the gas being active. To activate wire inch, push and hold the MIG torch switch until the display shows 'INCH WIRE'.

When the display shows 'INCH WIRE', release the MIG torch switch and press it again. The wire feed motor starts to rotate and ramp up to a speed of 10m/min while welding wire is pushed through without activating gas flow. Releasing the MIG torch switch will stop the wire inch function.

Please Note:

- During inch function, welding voltage is active.
- When wire inch mode is active, the cooling fan will start and stop when inch stops.

OPERATION MIG MANUAL



Before starting any welding activity ensure that you have suitable eye protection and protective clothing. Also take the necessary steps to protect any persons within the welding area.

MIG/MAG standard welding mode

Selecting MIG Welding mode:

Press the MIG/MMA/TIG icon to select MIG welding mode. Upon selecting MIG, only the MIG mode corresponding icon will be shown as circled red right.



Selecting MIG manual mode:

Press the Manual/Synergic/Pulse/Double Pulse icon to select MIG manual mode. Upon selecting manual, only the manual mode corresponding icon will be shown as circled red right.



Trigger Mode:

Press the 2T/4T/Spot icon to select the 2T torch trigger mode.

On selecting 2T, only the 2T icon will be shown as circled red right.

See page 86 for details on trigger modes.



Material, Wire Size and Gas choice:

In manual MIG mode, selecting material, wire size and shielding gas will still have an effect on the welding characteristics, for example improves default ignition and burnback settings.

Press in turn, the material, wire size and gas icon to select the relevant choices.

Upon selecting your chosen specifications, the corresponding icons will be shown as circled red below.

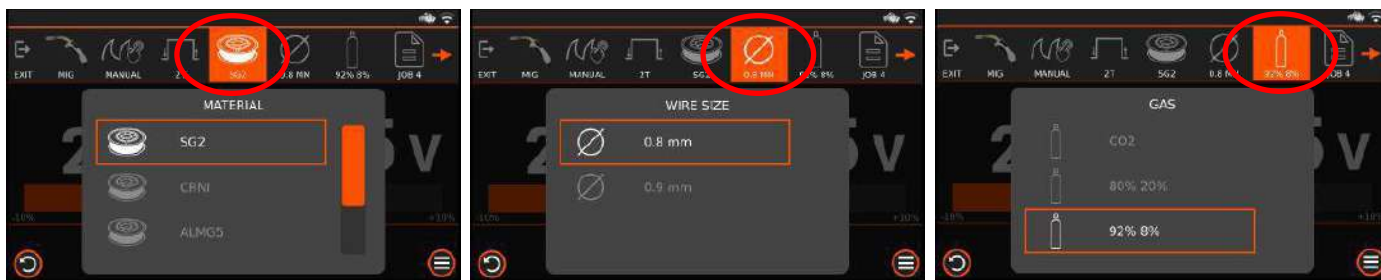

OPERATION MIG MANUAL



Before starting any welding activity ensure that you have suitable eye protection and protective clothing. Also take the necessary steps to protect any persons within the welding area.

MIG/MAG standard welding mode (Continued)

Wire Feed Speed Control

The control dial and display area right that is highlighted red when rotated in standard MIG mode gives the operator the ability to control wire feed speed.

Rotating the control dial clockwise increases wire feed speed (increasing welding current) while rotating the dial anti-clockwise will decrease the wire feed speed ultimately reducing welding current.

(The wire feed speed range is 0.8 to 18 m/min).

MIG Voltage Control

The control dial and display area right that is highlighted green when rotated in standard MIG mode gives the operator the ability to control welding voltage.

Rotating the control dial clockwise increases welding voltage while rotating the dial anti-clockwise will decrease the welding voltage. (The voltage range is 12 ~ 35 Volts DC).



Selecting and Adjusting Advanced Settings:

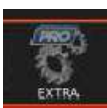

When in standard MIG mode, you can now adjust various MIG parameters such as pre and post gas flow, burnback time and inductance and these are adjusted via the extra screen that allows the users to adjust a number of background default parameters or functions.

Entering the advanced settings area by pressing the 'Extra' icon will give you access to adjust various other MIG feature parameter as follows.

Pregas Time, Inductance, Burn Back time and Postgas Time.

On entering the 'extra' option in manual MIG mode, the 'Advanced' drop down list will pop up and you can either rotate the left control dial to scroll through the selection or use the touch screen to select your chosen parameter for adjusting.

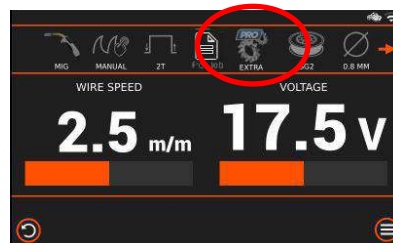

Pregas Timer: Initial gas time adjustment range is 0.1 to 10 Seconds.

Inductance: Inductance adjustment range is -10 to +10.

Burnback Time: Burnback time adjustment range is -10 to +10.

Postgas Timer: Final gas time adjustment range is 0.1 to 3 Seconds.

Restore Default Settings: Resetting MIG parameters to default settings.

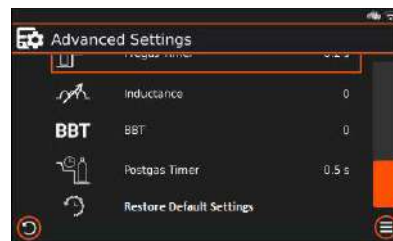

In the example shown right, pressing the Inductance option will open up the inductance adjustment pop up box and by rotating the left control dial either clockwise or anticlockwise you can adjust the setting, in this case the range being -10 to +10 and the example shows that its set to 5 (+5). You can also use the touch screen to slide the bar to make the adjustment.

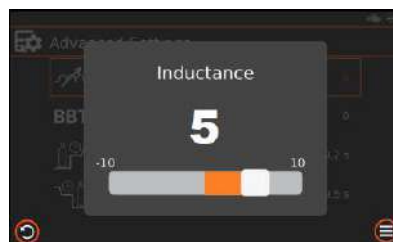

Once any adjustments are carried out, pressing the left control dial will automatically save and exit said parameter and take you back to the previous screen.

OPERATION - SYNERGIC MIG



Before starting any welding activity ensure that you have suitable eye protection and protective clothing. Also take the necessary steps to protect any persons within the welding area.

MIG/MAG Synergic Welding Mode

Synergic Welding Mode:

Synergic mode is where Welding Power (voltage) and Wire Feed Speed are adjusted together, (rather than separately), via a single control.

The Evolve 200 has been pre-programmed with various welding parameters including; MIG welding wire size, the material type and shielding gas being used.

With this information, the machine sets itself up with the ideal parameters for welding.

You can then for added convenience see and compare additional features such as material thickness being welded.

In most cases, It's wire feed speed within the machine's synergic programming that sets the welding power output to match your application. So, increasing wire feed speed will increase the machines power output to suit.

Selecting MIG mode:

Following on from manual MIG mode (see from page 65 for details) selecting MIG is easily actioned by pressing the MMA/TIG/MIG icon to select MIG welding mode. Upon selecting MIG, the MIG corresponding icon will be shown as circled red right.



Selecting Synergic MIG mode:

Press the Manual/Synergic/Pulse/Double Pulse icon to select MIG manual mode. Upon selecting synergic mode, only the Synergic corresponding icon will be shown as circled red right.

The control panel image right is an example of the Evolve 200 now set up in synergic MIG mode.



Material, Wire Size and Gas Selection:

In Synergic MIG mode, selecting material, wire size and shielding gas will have an effect on the welding characteristics, for example improves default ignition and burnback settings along with user setup ease.

Press in turn, the material, wire size and gas icon to select the relevant choices.

Upon selecting your chosen specifications, the corresponding icons will be shown as circled red below.

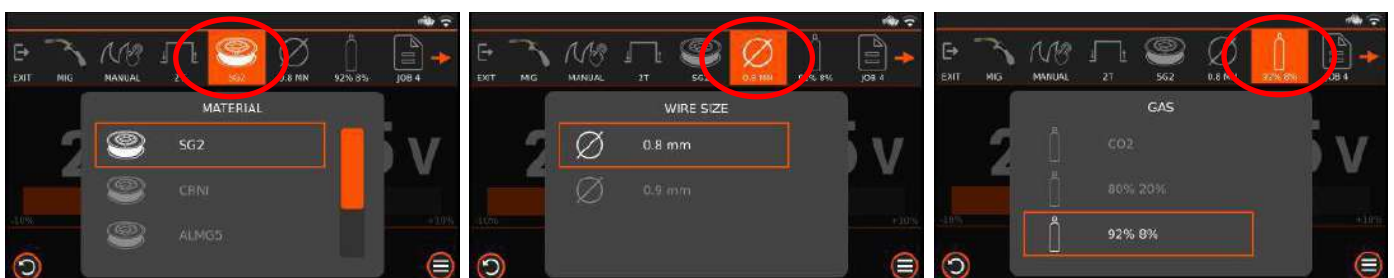

OPERATION - SYNERGIC MIG



Before starting any welding activity ensure that you have suitable eye protection and protective clothing. Also take the necessary steps to protect any persons within the welding area.

MIG/MAG Synergic Welding Mode: (Continued)

Synergic Welding Control:

When in synergic mode welding amperage (80A as shown right) control becomes the default adjustment setting as shown right, and the upper rotary encoder and push button which when pressed will scroll the operator through amperage control, wire feed speed and material thickness.

Synergic mode allows the operator to rotate the lower left control dial clockwise to increase not only the welding current but also the background wire feed speed and material thickness settings and rotating the dial anticlockwise will decrease the wire feed speed ultimately reducing welding current.

In the example shown left, when you increase current from 80A to 100A, you will note the following settings also increase via the screen:

- Wire feed speed increased from: 4.7mm to 6.0mm
- Material thickness increased from: 0.8mm to 1.6mm
- Welding voltage increased from: 14.5v to 18.1v



Arc Length Control:

Arc length control gives the operator the ability to have increased or reduced 'stick out' in synergic mode which enables further fine tuning or trimming by adjusting arc length and voltage in smaller increments. This allows the operator to trim and shape the weld bead profile. You can increase or decrease arc length voltage by up to -20 to +20 % of the programmed value. "0" is the mid point and when accessed will be shown in the voltage value.

Turning the lower right control dial anti-clockwise to shorten the arc length and rotating clockwise to lengthen the arc length and you can see in the image right that increasing the trim to 7% has also increased the welding voltage from 14.5v to 15.8v which is also noted via the slide bar in-between the arc length control (trim) readings.

Adjusting the trim up from 0 to +20 will increase the heat input into the material and give you the effect of having less wire and a longer welding arc.

Adjusting the trim down from 0 to -20 will reduce the heat input into the material and give you the effect of having more wire and a shorter welding arc.



Trigger Mode:

Press the 2T/4T/Spot icon to select the 2T torch trigger mode. On selecting 2T, only the 2T icon will be shown as circled red right.

See page 86 for details on torch trigger function.

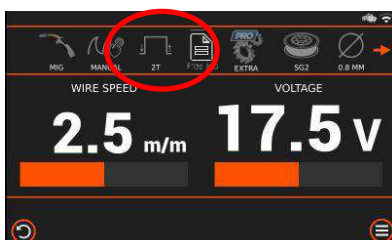

OPERATION - SYNERGIC MIG



Before starting any welding activity ensure that you have suitable eye protection and protective clothing. Also take the necessary steps to protect any persons within the welding area.

MIG/MAG Synergic Welding Mode: (Continued)

Advanced Settings Menu

Hot Start Mode:

Press the hot start icon to select turning ON or Off the Hot Start feature. When Hot Start is ON (active), within the extra's setting (advanced settings menu) you also have the option to turn on/off hot start but you also the options to adjust and set various other hot start features.



Selecting and Adjusting Advanced Settings:

 When in Synergic MIG mode, you can now adjust various MIG parameters such as pre and post gas flow, hot start, burnback time, inductance and slope settings and these are adjusted via the extra screen that allows the users to adjust a number of background default parameters or functions.

Entering the advanced settings area by pressing the 'Extra' icon will give you access to adjust various other MIG feature parameter such as, Pregas Time, Hot Start, Inductance, Burn Back time and Postgas Time etc.

On entering the 'extra' option in manual MIG mode, the 'Advanced' drop down list will appear and you can either rotate the left control dial to scroll through the selection or use the touch screen to select your chosen setting:

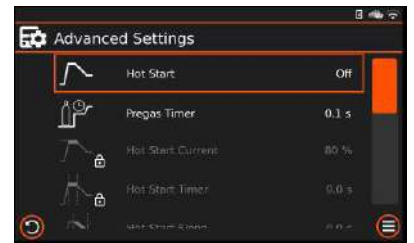

Hot Start Mode:

Pressing the hot start line will allow you to turn ON or Off the Hot Start. When Hot Start is OFF (as shown right), then Start Current, Start Timer and Start Slope are 'greyed' out and have a lock symbol next to them as shown right signifying that they are now inactive. When hot start is turned ON you will have the options to adjust and set the below hot start features.

- Start Current, adjustment range is 20 - 150%.
- Start Timer, adjustment range is 0 - 10 seconds.
- Start Slope adjustment range is 0 - 10 seconds.

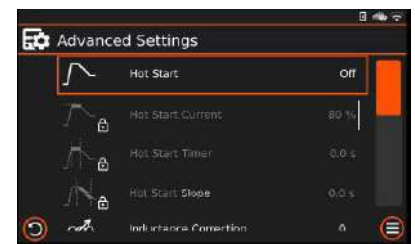

In the example shown below, Hot Star has been set to ON and pressing the Hot Start Current option will open up the start current adjustment pop up box and by rotating the left control dial either clockwise or anticlockwise you can adjust the setting, in this case the range being 20 to 150 % and the example shows that its set to 80%. You can also use the touch screen to slide the bar to make the adjustment.

Once any adjustments are carried out, pressing the left control dial will automatically save, exit said parameter and take you back to the previous screen.

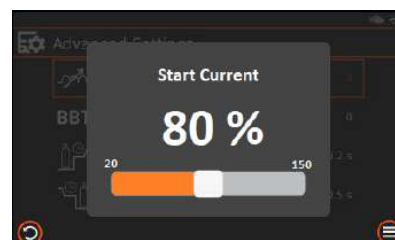
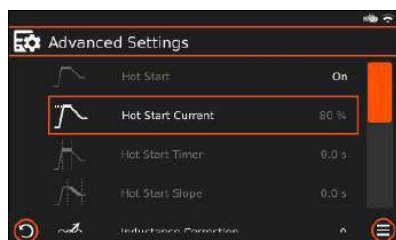

OPERATION - SYNERGIC MIG



Before starting any welding activity ensure that you have suitable eye protection and protective clothing. Also take the necessary steps to protect any persons within the welding area.

MIG/MAG Synergic Welding Mode:

Advanced Settings Menu (Continued)



On entering the 'extra' option in Synergic MIG mode, the 'Advanced settings' drop down selection list is quite extensive and using the touch screen you can slide the orange bar down to see and then access further adjustment parameters.

You can either rotate the left control dial to scroll through the selection and press the left control dial to access the required parameter or use the touch screen to select your chosen setting.

- Pregas Time:** Initial gas time adjustment range is 0.1 to 10 Seconds.
- Inductance:** Inductance adjustment range is -10 to +10.
- Burnback Time:** Burnback time adjustment range is -10 to +10.
- Stop Slope:** Slope down time, (peak to stop) current, adjustment range is 0.1 to 10 Seconds.
- Stop Current:** Stop (final) current value, adjustment range is 20 to 80% of peak value.
- Stop Timer:** Stop (final) current time, adjustment range is 0 to 10 Seconds.
- Postgas Timer:** Final gas time adjustment range is 0.1 to 3 Seconds.
- GLICK Level:** If 4T trigger mode is selected then Glick Level will also be highlighted and can be adjusted from 20 to 90% and off.

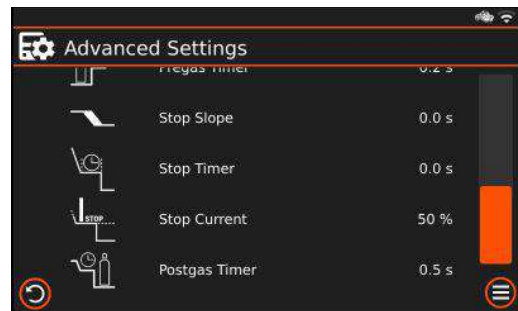
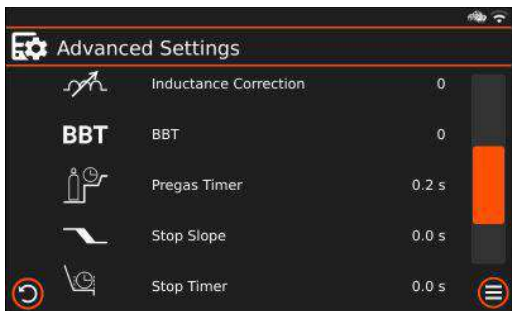

Restore Settings:

Resetting MIG parameters to factory settings.

This option will restore MIG synergic parameters back to factory settings.

Upon selecting synergic MIG Restore Default Settings option, a pop up window will be activated which will that allows the operator to restore synergic MIG parameters to the factory settings by selecting 'yes' as shown right.

Once confirmed, your choice is saved and you will be returned back to the advanced settings screen.

Pressing the cancel option will return you back to the previous screen and no changes will have been saved.

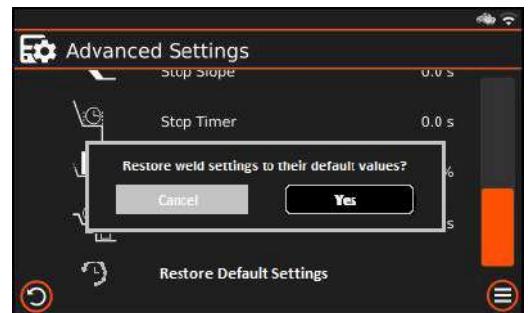

OPERATION - PULSE MIG



Before starting any welding activity ensure that you have suitable eye protection and protective clothing. Also take the necessary steps to protect any persons within the welding area.

MIG/MAG Pulse Welding Mode

Pulse Welding Mode:

Pulsed MIG is an advanced form of welding that takes the best of Dip and Spray forms of transfer while minimizing their disadvantages. Unlike Dip, pulsed MIG does not create spatter or run the risk of cold lapping without compromising penetration, so its an ideal process to use for thin and soft materials like aluminium or stainless steel.

Using a single pulse weld alternates between fixed peak current and background current.

- Reduced heat input, so you can weld thinner than standard MIG, perfect for aluminium
- Weld faster than with TIG welding, but offering the same aesthetic appearance as TIG
- Spatter free welding, cutting your clean-up time to nothing
- Great penetration even with lower heat

Pulse MIG is a non-contact transfer method between the electrode and the weld puddle. This means that the electrode (welding wire) never touches the puddle. This happens through high-speed manipulation of the output of the welding machine. It's a spatter free process that will run at a lower heat input than spray transfer method.

The pulsed MIG process works by crating one droplet of molten metal at the end of the electrode (wire) per pulse. Then, just the right amount of current is added to push that one droplet across the arc into the puddle. The transfer of these droplets occurs through the arc, one droplet per pulse.

During the process, the current rises to it's peak and the droplet is formed. Then, in background current mode, the current is lowered to reduce the overall heat input, so the height and width of the peak is important for proper transfer.

Pulsed MIG is one of the best welding processes for a wide variety of welding applications and metal types.

Selecting MIG mode:

Following on from Synergic MIG mode selecting MIG is the same and is actioned by pressing the MMA/TIG/MIG icon to select MIG welding mode.

Upon selecting MIG, the MIG corresponding icon will be shown as circled red right.

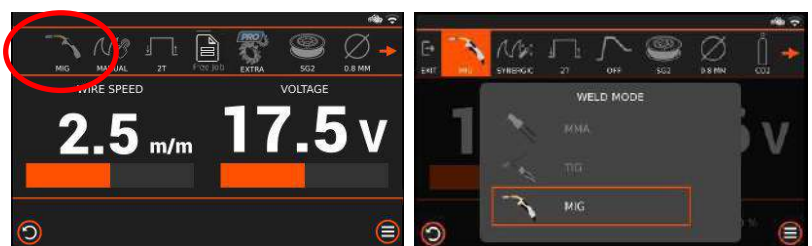

Selecting Pulse MIG mode:

Press the Manual/Synergic/Pulse/Double Pulse icon to select Pulse.

Upon selecting pulse mode, only the pulse corresponding icon will be shown as circled red right.

The control panel image right is an example of the Evolve 200 now set up in Pulse MIG mode.



Please Note:

Pulse MIG mode offers a fixed pulse setting, so pulse background settings are not adjustable.

OPERATION - PULSE MIG



Before starting any welding activity ensure that you have suitable eye protection and protective clothing. Also take the necessary steps to protect any persons within the welding area.

MIG/MAG Pulse Welding Mode: (Continued)

Pulse Welding Control:

When in Pulse mode welding amperage (80A as shown right) control becomes the default adjustment setting (as shown right, and the upper rotary encoder and push button which when pressed will scroll the operator through amperage control, wire feed speed and material thickness.

Pulse mode allows the operator to rotate the lower left control dial clockwise to increase not only the welding current but also the background wire feed speed and material thickness settings and rotating the dial anticlockwise will decrease the wire feed speed ultimately reducing welding current.

In the example shown left, when you increase current from 80A to 100A, you will note the following settings also increase via the screen:

- Wire feed speed increased from: 6mm to 8.1mm
- Material thickness increased from: 1.6mm to 2.4mm
- Welding voltage increased from: 18.1v to 21.1v



Arc Length Control:

Arc length control gives the operator the ability to have increased or reduced 'stick out' in synergic mode which enables further fine tuning or trimming by adjusting arc length and voltage in smaller increments.

This allows the operator to trim and shape the weld bead profile.

You can increase or decrease arc length voltage by up to -20 to +20 % of the programmed value. "0" is the mid point and when accessed will be shown in the voltage value.

Turning the lower right control dial anti-clockwise to shorten the arc length and rotating clockwise to lengthen the arc length and you can see in the image right that increasing the trim to 7% has also increased the welding voltage from 14.5v to 15.8v which is also noted via the slide bar in-between the arc length control (trim) readings.



Trigger Mode:

Press the 2T/4T/Spot icon to select the 2T torch trigger mode. On selecting 2T, only the 2T icon will be shown as circled red right.

See page 86 for details on MIG torch trigger function.



OPERATION - PULSE MIG



Before starting any welding activity ensure that you have suitable eye protection and protective clothing. Also take the necessary steps to protect any persons within the welding area.

MIG/MAG Pulse Welding Mode (Continued)

Material, Wire Size and Gas Selection:

In Pulse MIG mode, selecting material, wire size and shielding gas will have an effect on the welding characteristics as previously explained for Synergic welding mode.

Press in turn, the material, wire size and gas icon to select the relevant choices.

Upon selecting your chosen specifications, the corresponding icons will be shown as circled red below.

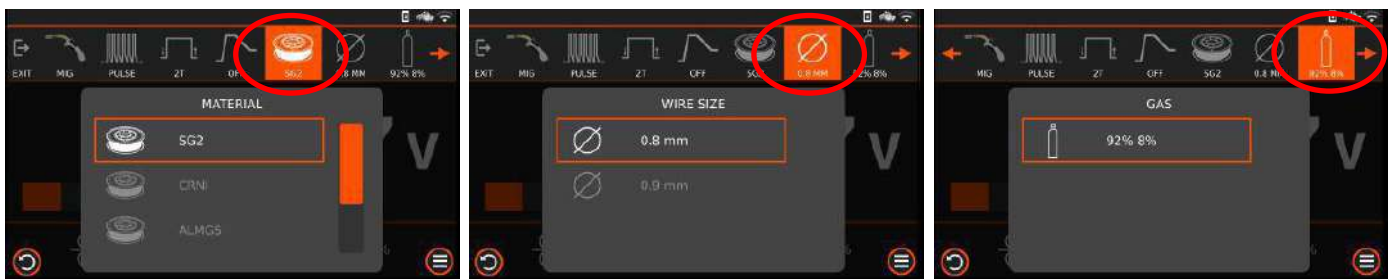

Hot Start Selection:

Press the hot start icon to select turning ON or Off the Hot Start feature. When Hot Start is ON (active), within the extra's setting (advanced settings menu) you also have the option to turn on/off hot start but you also the options to adjust and set various other hot start features.



Selecting and Adjusting Advanced Settings:

 When in Synergic MIG mode, you can now adjust various MIG parameters such as pre and post gas flow, hot start, burnback time, inductance and slope settings and these are adjusted via the extra screen that allows the users to adjust a number of background default parameters or functions.

Entering the advanced settings area by pressing the 'Extra' icon will give you access to adjust various other MIG feature parameter such as, Pregas Time, Hot Start, Inductance, Burn Back time and Postgas Time etc.

On entering the 'extra' option in manual MIG mode, the 'Advanced' drop down list will appear and you can either rotate the left control dial to scroll through the selection or use the touch screen to select your chosen setting.

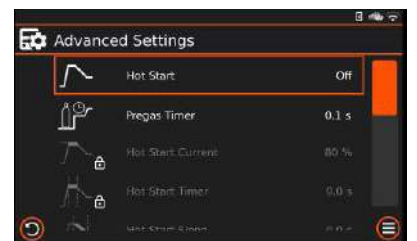

OPERATION - PULSE MIG



Before starting any welding activity ensure that you have suitable eye protection and protective clothing. Also take the necessary steps to protect any persons within the welding area.

MIG/MAG Pulse Welding Mode (Continued)

Advanced Settings Menu (Continued)

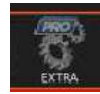

Hot Start Mode:

Pressing the hot start line will allow you to turn ON or Off the Hot Start. When Hot Start is OFF (as shown right), then Start Current, Start Timer and Start Slope are 'greyed' out in advanced settings and have a lock symbol next to them as shown right signifying that they are now inactive (as shown in the image at the bottom of this page). When hot start is turned ON you will have the options to adjust and set the below hot start features.

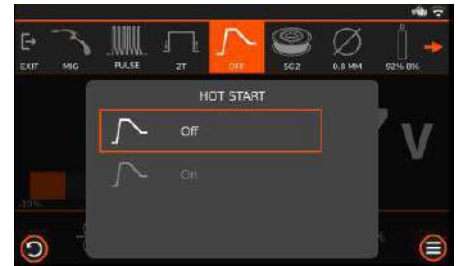

- Start Current, adjustment range is 20 - 150%.
- Start Timer, adjustment range is 0 - 10 seconds.
- Start Slope adjustment range is 0 - 10 seconds.

In the example shown below, Hot Star has been set to ON and pressing the Hot Start Current option will open up the start current adjustment pop up box and by rotating the left control dial either clockwise or anticlockwise you can adjust the setting, in this case the range being 20 to 150 % and the example shows that its set to 80%. You can also use the touch screen to slide the bar to make the adjustment.

Once any adjustments are carried out, pressing the left control dial will automatically save, exit said parameter and take you back to the previous screen.

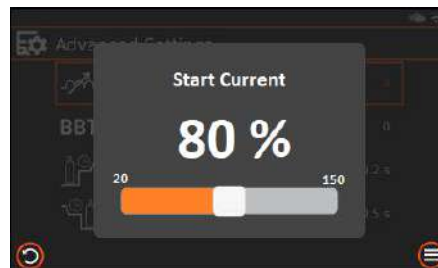
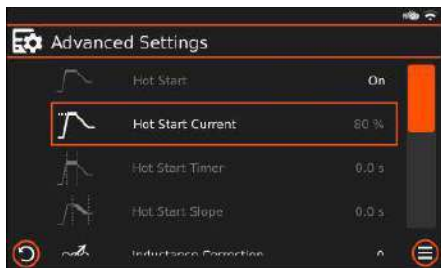

Start Force Mode:

Start force mode will offer an additional boost to initiating the welding arc in pulse and double pulse MIG mode only by increasing the welding voltage between 0 - 10%.

Pressing the Start Force option will open up the start force current adjustment pop up box and by rotating the left control dial either clockwise or anticlockwise you can adjust the setting from 0 to 10 %. You can also use the touch screen to slide the bar to make the adjustment.

Once any adjustments are carried out, pressing the left control dial will automatically save, exit said parameter and take you back to the previous screen.

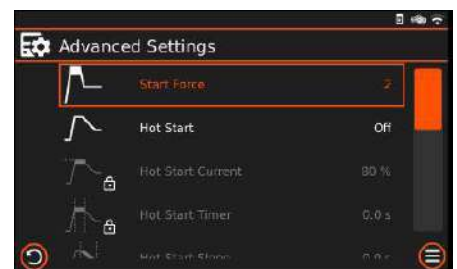

OPERATION - PULSE MIG



Before starting any welding activity ensure that you have suitable eye protection and protective clothing. Also take the necessary steps to protect any persons within the welding area.

MIG/MAG Pulse Welding Mode:

Advanced Settings Menu (Continued)



On entering the 'extra' option in Synergic MIG mode, the 'Advanced settings' drop down selection list is quite extensive and using the touch screen you can slide the orange bar down to see and then access further adjustment parameters.

You can either rotate the left control dial to scroll through the selection and press the left control dial to access the required parameter or use the touch screen to select your chosen setting:

- Pregas Time:** Initial gas time adjustment range is 0.1 to 10 Seconds.
- Inductance:** Inductance adjustment range is -10 to +10.
- Burnback Time:** Burnback time adjustment range is -10 to +10.
- Stop Slope:** Slope down time, (peak to stop) current, adjustment range is 0.1 to 10 Seconds.
- Stop Current:** Stop (final) current value, adjustment range is 20 to 80% of peak value.
- Stop Timer:** Stop (final) current time, adjustment range is 0 to 10 Seconds.
- Postgas Timer:** Final gas time adjustment range is 0.1 to 3 Seconds.
- GLICK Level:** If 4T trigger mode is selected then Glick Level will also be highlighted and can be adjusted from 20 - 90% and off.

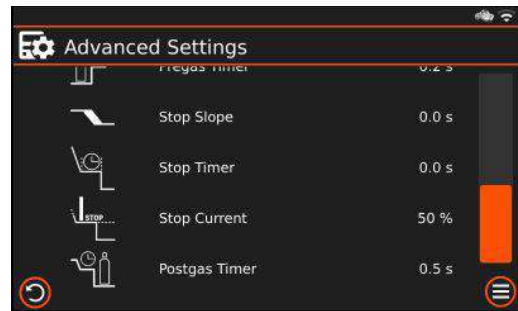
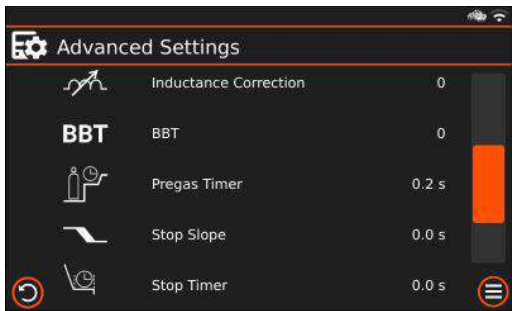

Restore Settings:

Resetting MIG parameters to factory settings.

This option will restore MIG pulse parameters back to factory settings.

Upon selecting pulse MIG Restore Default Settings option, a pop up window will be activated which will that allows the operator to restore synergic MIG parameters to the factory settings by selecting 'yes' as shown right.

Once confirmed, your choice is saved and you will be returned back to the advanced settings screen.

Pressing the cancel option will return you back to the previous screen and no changes will have been saved.

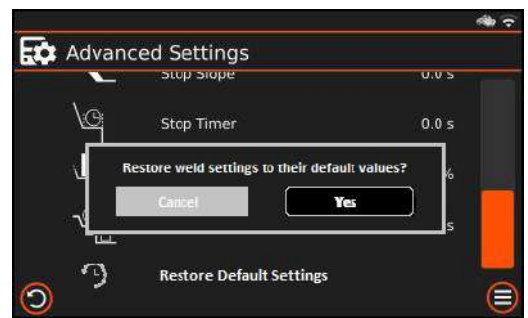

OPERATION - DOUBLE PULSE MIG



Before starting any welding activity ensure that you have suitable eye protection and protective clothing. Also take the necessary steps to protect any persons within the welding area.

MIG/MAG Double Pulse Welding Mode

Double Pulse Welding Mode:

As previously stated, manual MIG offers lower arc energy, and will function in dip or spray mode although in dip mode there will be short circuits and spatter. This can be useful on thin sections or positional welding as the higher energy of pulse can be too much for the puddle to stay controlled. However pulse allows the arc to enter spray transfer even at low currents and feed speeds allowing faster neater welding with higher deposition and smaller heat affected zones due to the extra arc energy. Double pulse MIG offers the operator back the ability to weld at a slower pace, an example could be around a tube for instance where moving the torch in a controlled manner quickly while not losing control of the weld puddle which can be a problem as it allows a certain amount of cooling and solidifying of the weldment buying you some time, it is also very useful for vertical up welding. What's important is using the correct weld process for the job in hand, rather than trying to make one type of output work on different application. For example, double pulse is not effective on material over 6mm unless vertical. You may drop down to Manual MIG for anything below about 1.5 to 2mm but use pulse and double pulse for anything in between although this can depend greatly on the application.

Selecting MIG mode:

Following on from pulse MIG mode setup selecting MIG is easily actioned by pressing the MMA/TIG/MIG icon to select MIG welding mode.

Upon selecting MIG, the MIG corresponding icon will be shown as circled red right.



Selecting Double Pulse MIG mode:

Press the Manual/Synergic/Pulse/Double Pulse icon to select MIG manual mode. Upon selecting synergic mode, only the double pulse corresponding icon will be shown as circled red right.

The control panel image right is an example of the Evolve 200 now set up in double pulse MIG mode.



Material, Wire Size and Gas Selection:

In double pulse MIG mode, selecting material, wire size and shielding gas will have an effect on the welding characteristics, for example improves default ignition and burnback settings.



Press in turn, the material, wire size and gas icon to select the relevant choices.

Upon selecting your chosen specifications, the corresponding icons will be shown as circled red below.

OPERATION - DOUBLE PULSE MIG



Before starting any welding activity ensure that you have suitable eye protection and protective clothing. Also take the necessary steps to protect any persons within the welding area.

MIG/MAG Double Pulse Welding Mode: (Continued)

Double Pulse Welding Control:

When in Double Pulse mode welding amperage (80A as shown right) control becomes the default adjustment setting (as shown right, and the upper rotary encoder and push button which when pressed will scroll the operator through amperage control, wire feed speed and material thickness.

Double pulse mode allows the operator to rotate the lower left control dial clockwise to increase not only the welding current but also the background wire feed speed and material thickness settings and rotating the dial anticlockwise will decrease the wire feed speed ultimately reducing welding current.

In the example shown left, when you increase current from 80A to 100A, you will note the following settings also increase via the screen:

- Wire feed speed increased from: 6mm to 8.1mm
- Material thickness increased from: 1.6mm to 2.4mm
- Welding voltage increased from: 18.1v to 21.1v

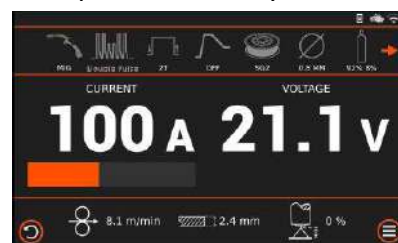

Arc Length Control:

Arc length control gives the operator the ability to have increased or reduced 'stick out' in synergic mode which enables further fine tuning or trimming by adjusting arc length and voltage in smaller increments. This allows the operator to trim and shape the weld bead profile.

You can increase or decrease arc length voltage by up to -20 ~ +20 % of the programmed value. "0" is the mid point and when accessed will be shown in the voltage value.

Turning the lower right control dial anti-clockwise to shorten the arc length and rotating clockwise to lengthen the arc length and you can see in the image right that increasing the trim to 7% has also increased the welding voltage from 14.5v to 15.8v which is also noted via the slide bar in-between the arc length control (trim) readings.



Trigger Mode:

Press the 2T/4T/Spot icon to select the 2T torch trigger mode.

On selecting 2T, only the 2T icon will be shown as circled red right.

See page 86 for details on MIG torch trigger function.



OPERATION - DOUBLE PULSE MIG



Before starting any welding activity ensure that you have suitable eye protection and protective clothing. Also take the necessary steps to protect any persons within the welding area.

MIG/MAG Pulse Welding Mode: (Continued)

Advanced Settings Menu



Start Force Mode:

Start force mode will offer an additional boost to initiating the welding arc in pulse and double pulse MIG mode only by increasing the welding voltage between 0 - 10%.

Pressing the Start Force option will open up the start force current adjustment pop up box and by rotating the left control dial either clockwise or anticlockwise you can adjust the setting from 0 to 10 %. You can also use the touch screen to slide the bar to make the adjustment.

Once any adjustments are carried out, pressing the left control dial will automatically save, exit said parameter and take you back to the previous screen.

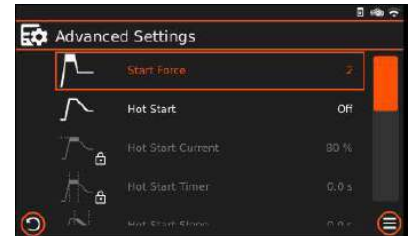

Hot Start Mode:

Press the hot start icon to select turning ON or Off the Hot Start feature.

When Hot Start is ON (active), within the extra's setting (advanced settings menu) you also have the option to turn on/off hot start but also you have the options to adjust and set:

- Start Current, adjustment range is 20 - 150%.
- Start Timer, adjustment range is 0 - 10 seconds.
- Start Slope adjustment range is 0 - 10 seconds.

When Hot Start is OFF, then Start Current, Start Timer and Start Slope are 'greyed' out and have a lock symbol next to them as shown right.

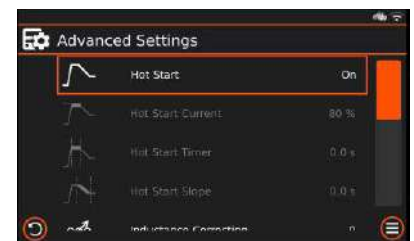

OPERATION - DOUBLE PULSE MIG



Before starting any welding activity ensure that you have suitable eye protection and protective clothing. Also take the necessary steps to protect any persons within the welding area.

MIG/MAG Double Pulse Welding Mode:

Advanced Settings Menu (Continued)



On entering the 'extra' option in Double Pulse MIG mode, the 'Advanced settings' drop down selection list is quite extensive and using the touch screen you can slide the orange bar down to see and then access further adjustment parameters.

You can either rotate the left control dial to scroll through the selection and press the left control dial to access the required parameter or use the touch screen to select your chosen setting as shown below:

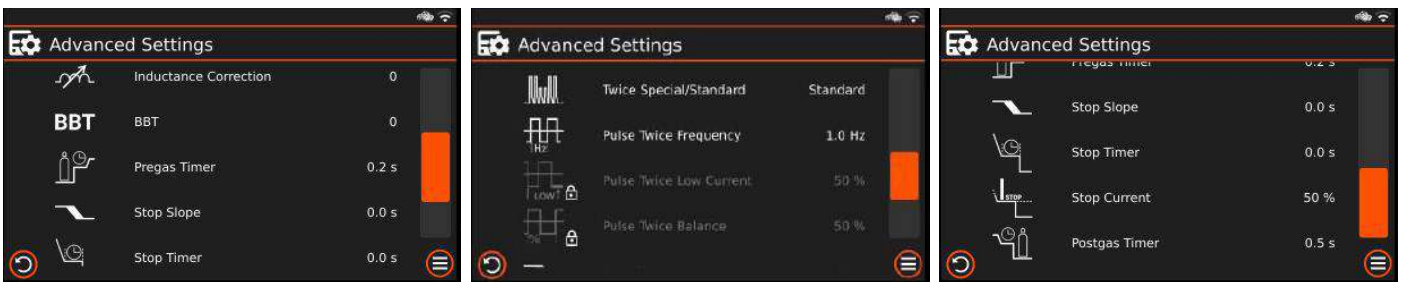

- | | |
|----------------------------------|--------------------------------------------------------------------------------------------------------------------------------------------------------------------------------------------------------------------------------------------------------------------|
| Pregas Time: | Initial gas time adjustment range is 0.1 to 10 Seconds. |
| Inductance: | Inductance adjustment range is -10 to +10. |
| Burnback Time: | Burnback time adjustment range is -10 to +10. |
| Double Pulse Mode: | Setting double pulse mode to either standard or advanced double pulse control.
→ In standard mode, you can only adjust double pulse frequency.
→ In advanced mode, you can adjust Double Pulse Frequency, Double Pulse Low Current and Double Pulse Balance. |
| Double Pulse Frequency: | Double pulse frequency adjustment range is from 0.5 to 5Hz. |
| Double Pulse Low Current: | Double pulse balance adjustment range is from 10 to 90%. |
| Double Pulse Balance: | Double pulse balance adjustment range is from 10 to 90%. |
| Stop Slope: | Slope down time, (peak to stop) current, adjustment range is 0.1 to 10 Seconds. |
| Stop Current: | Stop (final) current value, adjustment range is 20 to 80% of peak value. |
| Stop Timer: | Stop (final) current time, adjustment range is 0 to 10 Seconds. |
| Postgas Timer: | Final gas time adjustment range is 0.1 to 3 Seconds. |
| GLICK Level: | If 4T trigger mode is selected then Glick Level will also be highlighted and can be adjusted from 20 - 90% and off. |
| Restore Settings: | Resetting MIG parameters to factory settings. |

OPERATION - DOUBLE PULSE MIG



Before starting any welding activity ensure that you have suitable eye protection and protective clothing. Also take the necessary steps to protect any persons within the welding area.

MIG/MAG Double Pulse Welding Mode:

Advanced Settings Menu (Continued)



Restore Settings: Resetting Double Pulse MIG parameters to factory settings.

This option will restore Double Pulse parameters back to factory settings. Upon selecting MIG Restore Default Settings option, a pop up window will be activated which will that allows the operator to restore Double Pulse MIG parameters to the factory settings by selecting 'yes' as shown right.

Once confirmed, your choice is saved and you will be returned back to the advanced settings screen.

Pressing the cancel option will return you back to the previous screen and no changes will have been saved.

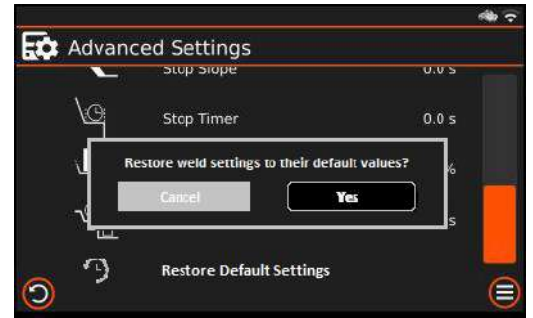

SET-UP GUIDE

STANDARD MIG/MAG

Standard MIG welding, set up as below and select 2T/4T trigger mode dependant on user requirements.
Material type and wire size selection will have no effect in standard MIG/MAG mode.

This multi icon bar shows the operator a quick view of MIG options and settings.
 The icons shown will change depending on MIG background settings.
 Pressing the icons will allow entry to chosen setting.

MIG Mode Manual Mode 2T Mode Extra Menu Set Accordingly

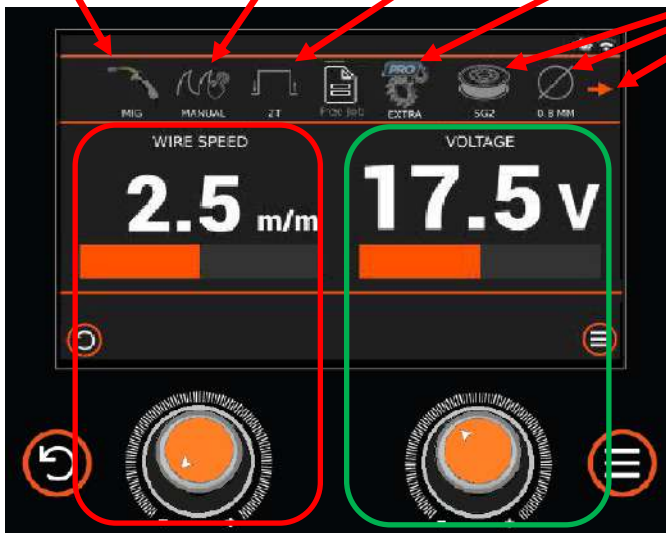

Pressing the EXTRA icon will open up the advanced settings menu, from here you can select various additional MIG options as shown in the below table.

Rotating and pressing the left control dial will allow you to select, adjust and save MIG parameter settings. You can also use the touch screen to navigate through and adjust settings as recommended below.

The control dial and display area left that is highlighted red when rotated clockwise or anti-clockwise in standard MIG mode gives the operator the ability to control wire feed speed.

The control dial and display area left that is highlighted green when rotated clockwise or anti-clockwise in standard MIG mode gives the operator the ability to control welding voltage.

Parameter	Units	Adjustable Range	Guide Setting	Notes
Job/Material	---	---	---	
PRE-GAS TIME	Seconds	0 ~ 10	0.5	
INDUCTANCE	-	-10 ~ +10	0	
BURNBACK TIMER	-	-10 ~ +10	0	
POST-GAS TIME	Seconds	0.1~ 10	2.0	
Wire Feed Speed	m/m	0.8 ~ 18	User Defined *	
Voltage	V	12 ~ 35	User Defined *	

* Depends on a number of factors, including: material type, weld prep and material thickness will determine the settings of voltage and wire feed speed.

SET-UP GUIDE

SYNERGIC MIG/MAG

For Synergic MIG welding, set up as below and select 2T/4T trigger mode dependant on user requirements.

This multi icon bar shows the operator a quick view of MIG options and settings. The icons shown will change depending on MIG background settings. Pressing the icons will allow entry to chosen setting.

MIG Mode Synergic Mode 2T Mode Set Accordingly Further Menu options (including Extra)



Once you have set the machine to MIG mode and synergic mode, it's important that you set the following up correctly:

- Set the material type.
- Set the wire size being used.
- Set shielding gas being used.

The above settings are crucial in order to set up the MIG synergic programs correctly.

Pressing and then rotating the left control dial will allow you to select, adjust, recall and save various MIG welding parameter settings. You can also use the touch screen to navigate through and adjust settings as recommended below.

Pressing the EXTRA icon will open up the advanced settings menu and from here you can select various additional MIG welding parameters as shown in the below table.

Rotating and pressing the left control dial will allow you to select, adjust and save MIG parameter settings. You can also use the touch screen to navigate through and adjust settings as recommended below.

The left control dial and display areas highlighted red when rotated clockwise or anti-clockwise in synergic MIG mode gives the operator the ability to control, adjust and see simultaneously welding current, wire feed speed and material thickness change to suit the required settings. The adjustable range will be determined by the material type, wire size and shielding gas that has been selected.

The right control dial and display area that is highlighted green when rotated in synergic MIG mode gives the operator the ability to control voltage trim (stick out).

Parameter	Units	Adjustable Range	Guide Setting	Notes
Job/Material	---	---	---	
Hot Start	-	On / Off	Off	
PRE-GAS TIME	Seconds	0 ~ 10	0.2	
START CURRENT	% (of peak)	20 ~ 150	80	
START CURRENT TIME	Seconds	0 ~ 10	0	Not available in 4T
START SLOPE	Seconds	0 ~ 10	0	
INDUCTANCE	-	-10 ~ +10	0	
BURNBACK TIMER	-	-10 ~ +10	0	
STOP SLOPE	Seconds	0 ~ 10	0	
STOP CURRENT TIME	Seconds	0 ~ 10	0	Not available in 4T
STOP CURRENT	% (of peak)	20 ~ 150	50	
POST-GAS TIME	Seconds	0.1 ~ 10	0.5	
GLICK Level	%	20 ~ 90% ~ Off	Off	Not available in 2T

SET-UP GUIDE

PULSE MIG/MAG

For Pulse MIG welding, set up as below and select 2T/4T trigger mode dependant on user requirements.

This multi icon bar shows the operator a quick view of MIG options and settings. The icons shown will change depending on MIG background settings. Pressing the icons will allow entry to chosen setting.

MIG Mode Pulse Mode 2T Mode Set Accordingly Further Menu options (including Extra)

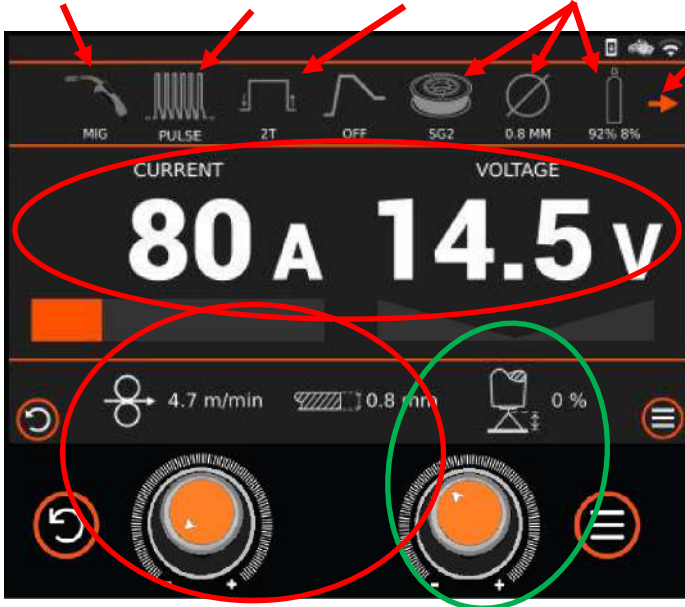

Once you have set the machine to MIG mode and synergic mode, it's important that you set the following up correctly:

- Set the material type.
- Set the wire size being used.
- Set shielding gas being used.

The above settings are crucial in order to set up the MIG synergic programs correctly.

Pressing and then rotating the left control dial will allow you to select, adjust, recall and save various MIG welding parameter settings. You can also use the touch screen to navigate through and adjust settings as recommended below.

Pressing the EXTRA icon will open up the advanced settings menu and from here you can select various additional MIG welding parameters as shown in the below table.

Rotating and pressing the left control dial will allow you to select, adjust and save MIG parameter settings. You can also use the touch screen to navigate through and adjust settings as recommended below.

The left control dial and display areas highlighted red when rotated clockwise or anti-clockwise in synergic MIG mode gives the operator the ability to control, adjust and see simultaneously welding current, wire feed speed and material thickness change to suit the required settings. The adjustable range will be determined by the material type, wire size and shielding gas that has been selected

The right control dial and display area that is highlighted green when rotated in synergic MIG mode gives the operator the ability to control voltage trim (stick out).

Parameter	Units	Adjustable Range	Guide Setting	Notes
Job/Material	---	---	---	
Start Force	%	0 ~ 10	3	
Hot Start	-	On / Off	Off	
PRE-GAS TIME	Seconds	0 ~ 10	0.2	
START CURRENT	% (of peak)	20 ~ 150	80	
START CURRENT TIME	Seconds	0 ~ 10	0	Not available in 4T
START SLOPE	Seconds	0 ~ 10	0	
INDUCTANCE	-	-10 ~ +10	0	
BURNBACK TIMER	-	-10 ~ +10	0	
STOP SLOPE	Seconds	0 ~ 10	0	
STOP CURRENT TIME	Seconds	0 ~ 10	0	Not available in 4T
STOP CURRENT	% (of peak)	20 ~ 150	50	
POST-GAS TIME	Seconds	0.1 ~ 10	0.5	
GLICK Level	%	20 ~ 90% ~ Off	Off	Not available in 2T

SET-UP GUIDE

DOUBLE PULSE MIG/MAG

For Double Pulse MIG welding, set up as below and select 2T/4T trigger mode dependant on user requirements.

This multi icon bar shows the operator a quick view of MIG options and settings. The icons shown will change depending on MIG background settings. Pressing the icons will allow entry to chosen setting.

MIG Mode Double Pulse Mode 2T Mode Set Accordingly Further Menu options (including Extra)



Once you have set the machine to MIG mode and synergic mode, it's important that you set the following up correctly:

- Set the material type.
- Set the wire size being used.
- Set shielding gas being used.

The above settings are crucial in order to set up the MIG synergic programs correctly.

Pressing and then rotating the left control dial will allow you to select, adjust, recall and save various MIG welding parameter settings. You can also use the touch screen to navigate through and adjust settings as recommended below.

Pressing the EXTRA icon will open up the advanced settings menu and from here you can select various additional MIG welding parameters as shown in the below table.

Rotating and pressing the left control dial will allow you to select, adjust and save MIG parameter settings. You can also use the touch screen to navigate through and adjust settings as recommended below.

The left control dial and display areas highlighted red when rotated clockwise or anti-clockwise in synergic MIG mode gives the operator the ability to control, adjust and see simultaneously welding current, wire feed speed and material thickness change to suit the required settings. The adjustable range will be determined by the material type, wire size and shielding gas that has been selected

The right control dial and display area that is highlighted green when rotated in synergic MIG mode gives the operator the ability to control voltage trim (stick out).

Parameter	Units	Adjustable Range	Guide Setting	Notes
Job/Material	---	---	---	
Start Force	%	0 ~ 10	3	
Hot Start	-	On / Off	Off	
PRE-GAS TIME	Seconds	0 ~ 10	0.2	
START CURRENT	% (of peak)	20 ~ 150	80	
START CURRENT TIME	Seconds	0 ~ 10	0	Not available in 4T
START SLOPE	Seconds	0 ~ 10	0	
INDUCTANCE	-	-10 ~ +10	0	
BURNBACK TIMER	-	-10 ~ +10	0	
DOUBLE PULSE MODE	-	Standard/Advanced	User choice	
DOUBLE PULSE FREQUENCY	Hz	0.5 ~ 5	1	
DOUBLE PULSE LOW CURRENT	%	10 ~ 90	50	Not available in pulse standard
DOUBLE PULSE BALANCE	%	10 ~ 90	50	Not available in pulse standard
STOP SLOPE	Seconds	0 ~ 10	0	
STOP CURRENT TIME	Seconds	0 ~ 10	0	Not available in 4T
STOP CURRENT	% (of peak)	20 ~ 150	50	
POST-GAS TIME	Seconds	0.1 ~ 10	0.5	
GLICK Level	%	20 ~ 90% ~ Off	Off	Not available in 2T

OPERATION - MIG

Torch trigger operation modes

2T MIG torch operation mode

Press the torch trigger to initiate the welding arc, the arc is extinguished when you release the trigger.

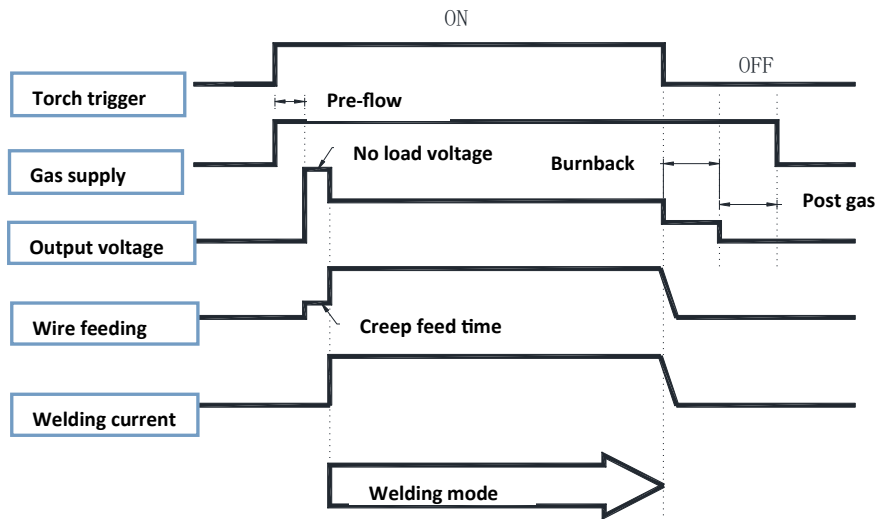

4T MIG torch operation mode

When the torch trigger is pressed to start the process, welding begins and continues to work even after the torch trigger is released (current and voltage setting dials on the control panel will still adjust the welding condition).

At this time, the digital meters will display the actual current and voltage respectively.

When torch trigger is pressed again, stopping the arc is effected (welding/crater current and crater voltage parameters in the welding settings can adjust welding condition).

The welding process stops when the torch trigger is released and post flow gas time will start.

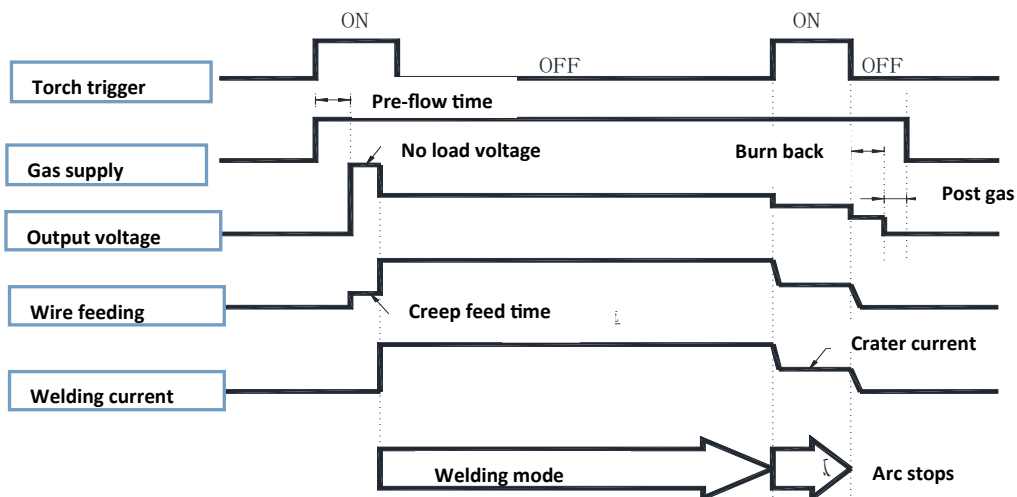

GUIDE TO MIG/MAG WELDING



Before starting any welding activity ensure that you have suitable eye protection and protective clothing. Also take the necessary steps to protect any persons within the welding area.

MIG process description

The MIG process was first patented for the welding of aluminium in 1949 in the USA. The process uses the heat that is generated by an electric arc formed between a bare consumable wire electrode and the work piece. This arc is shielded by a gas to prevent oxidation of the weld.

In the MIG process an inert shielding gas is used to protect the electrode and weld pool from contamination and enhance the arc. Originally this gas was helium.

In the early 1950's the process became popular in the UK for welding aluminium using argon as the shielding gas. Development in the use of different gases resulted in the MAG process. This is where other gases were used, for example, carbon dioxide and sometimes users

refer to this process as CO² welding. Gases such as oxygen and carbon dioxide were added and are active constituents to the inert gas to improve the welding performance. Although the MAG process is in common use today it is still referred to as MIG welding although technically this is not correct. This process began to prove itself as an alternative to stick electrode (MMA) and TIG (GTAW) offering high productivity and deposition rates.

The process also helps reduce any weld defects from the increased stop/starts used in MMA. However, the welder must have a good knowledge of the system set up and maintenance to achieve satisfactory welds.

The electrode MIG gun is normally +VE and the work return is normally -VE. However, certain consumable wires sometimes require what is called reverse polarity i.e. Electrode -VE or work +VE. Typically these types of wire are cored wires used in hard facing or high deposition and gasless applications.

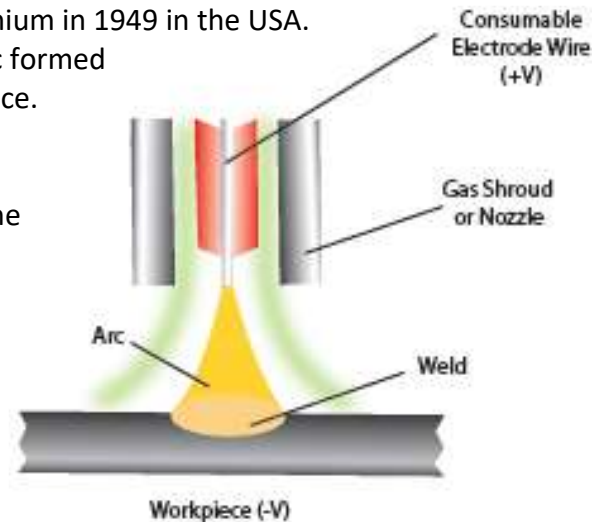

Typical welding ranges

Wire Diameter (mm)	DIP Transfer		Spray Transfer	
	Current (A)	Voltage (V)	Current (A)	Voltage (V)
0.6	30 ~ 80	15 ~ 18	n/a	n/a
0.8	45 ~ 180	16 ~ 21	150 ~ 250	25 ~ 33
1.0	70 ~ 180	17 ~ 22	230 ~ 300	26 ~ 35
1.2	60 ~ 200	17 ~ 22	250 ~ 400	27 ~ 35

GUIDE TO MIG/MAG WELDING

Before starting any welding activity ensure that you have suitable eye protection and protective clothing. Also take the necessary steps to protect any persons within the welding area.

Notes for the welding beginner

This section is designed to give the beginner who has not yet done any welding some information to get them going. The simplest way to start is to practice by running weld beads on a piece of scrap plate. Start by using mild steel (paint free) plate of 6.0mm thick and using 0.8mm wire. Clean any grease, oil and loose scale from the plate and fix firmly to your work bench so that welding can be carried out. Make sure that the work return clamp is secure and making good electrical contact with the mild steel plate, either directly or through the work table. For best results always clamp the work lead directly to the material being welded, otherwise a poor electrical circuit may create itself.

MIG/MAG process features and benefits

Terms used: MIG - Metal Inert Gas Welding
MAG - Metal Active Gas Welding
GMAW - Gas Metal Arc Welding

MIG welding was developed to help meet production demands of the war and post war economy which is an arc welding process in which a continuous solid wire electrode is fed through a MIG welding gun and into the weld pool, joining the two base materials together. A shielding gas is also sent through the MIG welding gun and protects the weld pool from contamination which also enhances the arc.

The MIG/MAG process can be used to weld a wide variety of materials and is normally used in the horizontal position but can be used in vertical or overhead with the correct selection of machine, wires and current. In addition, it can be used to weld at long distances from the power source subject to the correct cable sizing.

It is the dominant process used in maintenance and repair industries and is used extensively in structural and fabrication work.

Weld quality is also highly dependent on the skill of the operator and many welding problems can exist due to incorrect installation application and use.

Welding position

When welding, ensure you place yourself in a comfortable position for welding and your welding application before you begin to weld. This maybe by sitting at a suitable height which often is the best way to weld ensuring you're relaxed and not tense. A relaxed posture will ensure the welding task becomes much easier.

Please ensure you always wear suitable PPE and use suitable fume extraction when welding.

Place the work so that the direction of welding is across, rather than to or from your body.

The electrode holder lead should always be clear of any obstruction so that you can move your arm freely along as the electrode burns down. Some elders prefer to have the welding lead over their shoulder, this allows greater freedom of movement and can reduce the weight from your hand.

Always inspect your welding equipment, welding cables and electrode holder before each use to ensure it is not faulty or worn as you may be at risk of an electric shock.

GUIDE TO MIG/MAG WELDING



Before starting any welding activity ensure that you have suitable eye protection and protective clothing. Also take the necessary steps to protect any persons within the welding area.

MIG controls

The main basic controls for the MIG/MAG system are wire feed speed and voltage.

Wire feed speed

The wire speed is directly related to the current. The higher the wire speed the more wire is deposited and hence more current is required to burn off the consumable wire.

Wire speed is measured in m/min (metres per min) or sometimes in ipm (inches per minute).

The diameter of the wire also forms part of the current demand e.g. a 1.0mm wire feeding at 3m per minute will require less current than a 1.2mm wire feeding at the same rate. The wire feed is set according to the material to be welded.

If the wire feed rate is too high in comparison to the voltage then a “stubbing” effect happens where un-melted consumable contacts the work piece creating large amounts of weld spatter.

Too little wire feed comparison to the voltage will result in a long arc being created with poor transfer and eventual burning back of the welding wire onto the contact tip.



Wire Speed Feed

Welding Voltage

Please Note:

The Evolve 200 machines top display defaults to wire feed speed, when welding starts a pop-up screen will then display ‘actual’ welding current and welding voltage.

Voltage setting

The voltage polarity in MIG/MAG welding is in the majority of cases with the positive (+). This means that the majority of the heat is in the electrode wire.

Certain special wires may require the polarity to be reversed i.e. electrode wire negative (-) polarity.

Always consult the manufacturer's data sheet for the best operating parameters.

The voltage is often referred to as the “heat setting”. This will be altered dependent on the material type, thickness, gas type, joint type and position of the weld. Combined with the wire speed it is the main control adjusted by the welder. The voltage setting varies depending on the type and size of electrode wire being used.

Most MIG/MAG welders are CV (Constant Voltage) power sources which means the voltage does not vary much during welding. Modern inverter power sources also have control circuits to monitor conditions to ensure voltage remains constant.

The voltage determines height and width of the weld bead. If the operator has no reference to settings required the best method of set up is to use scrap material of the same thickness to obtain the correct setting. If there is too much voltage the arc will be long and uncontrollable and cause the wire to fuse to the contact tip. If the voltage is too low then there will not be enough heat to melt the wire and then stubbing occurs.

To obtain a satisfactory weld, a balance needs to be made between voltage and wire speed.

Characteristics of the voltage are that the higher voltage produces a flatter and wider weld bead but care must be taken to avoid undercut. The lower the voltage the weld bead becomes narrow and higher.

GUIDE TO MIG/MAG WELDING



Before starting any welding activity ensure that you have suitable eye protection and protective clothing. Also take the necessary steps to protect any persons within the welding area.

Modes of Transfer

Dip or short circuit mode

In the dip or short circuit, the wire (electrode) touches the work piece and a short circuit is created. The wire will short circuit the base metal between 90 and 200 times per second. This method has the benefit of creating a small, quickly solidifying weld puddle. The deposition rates, wire speed and voltages are usually lower than other modes of transfer and the low heat input makes it a flexible mode for both thick and thin metals in all positions.

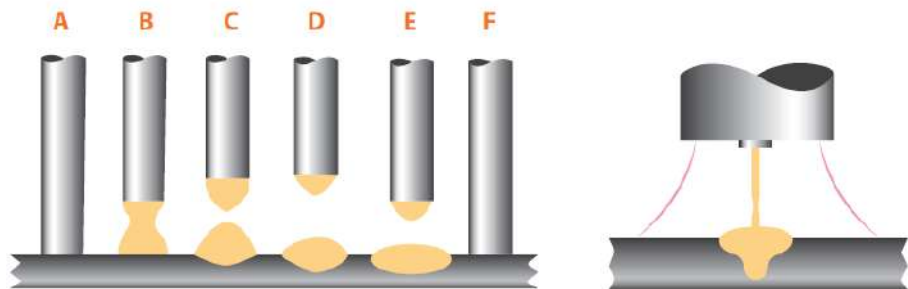

- A - Consumable wire feed to work piece and short circuit is created
- B - Wire starts to melt due to short circuit current
- C - Wire pinches off
- D - Arc length opens due to burn off
- E - Wire advances towards the work piece
- F - Wire short circuits and the process cycles again

Some of the disadvantages of this method are limited wire feed speed and hence weld deposition rates. On thicker material there can also be a danger of “cold lapping” occurring. This occurs when there is not enough energy in the weld puddle to fuse properly.

Another disadvantage is that this mode produces an increased amount of spatter due to the short circuits especially compared to the other transfer methods.

An inductance is used to control the surge in current when the wire dips into the weld pool.

Modern electronic power sources can automatically set the inductance to give a smooth arc and metal transfer.

Globular Transfer Mode

The globular transfer method is in effect an uncontrolled short circuit which occurs when the voltage and wire are above the dip range but too low for spray. Large irregular globules of metal are transferred between the torch and work piece under the force of gravity.

The disadvantages of this method of transfer are that it produces a large amount of spatter as well as high heat input. In addition, globular transfer is limited to flat and horizontal fillet welds above 3mm. Lack of fusion is often common because the spatter disrupts the weld puddle. Also, because globular transfer uses more wire it is generally considered less efficient.

The advantages of globular transfer are that it runs at high wire feed speeds and amperages for good penetration on thick metals. Also, when weld appearance is not critical it can be used with inexpensive, CO₂ shielding gas.

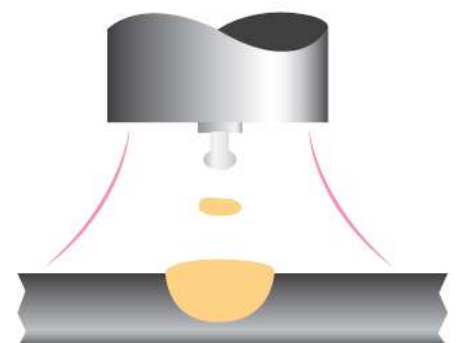

GUIDE TO MIG/MAG WELDING



Before starting any welding activity ensure that you have suitable eye protection and protective clothing. Also take the necessary steps to protect any persons within the welding area.

Modes of Transfer

Spray Arc Mode

The Spray arc mode is used with high voltage and current. Metal is projected in the form of a fine spray of molten droplets of the electrode, propelled across the arc to the work piece by an electromagnetic force without the wire touching the weld pool.

Its advantages include high deposition rates, good penetration, strong fusion, excellent weld appearance with little spatter as no short circuits are occurring.

The disadvantages of the spray arc mode are mainly due to the high heat input which can cause problems on thinner material and the limited range of welding positions where the mode can be used. Generally, the minimum thickness to be welded will be around 6mm.

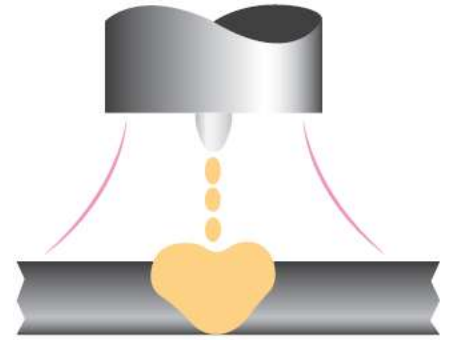

Pulsed Arc Mode

Pulsed MIG is an advanced form of welding that takes the best of all the other forms of transfer while minimizing or eliminating their disadvantages.

Unlike short circuit, pulsed MIG does not create spatter or run the risk of cold lapping. The welding positions in pulsed MIG are not limited as they are with globular or spray and its wire use is definitely more efficient. By cooling off the spray arc process, pulsed MIG is able to expand its welding range and its lower heat input does not encounter the problems on thinner materials.

In basic terms, pulsed MIG is a transfer method where material is transferred between the electrode and the weld puddle in controlled droplet form. This is achieved by controlling the electrical output of the welding machine using the latest control technologies.

The pulsed MIG process works by forming one droplet of molten metal at the end of the wire electrode per pulse. When ready the pulse of current is used to propel that one droplet across the arc and into the puddle.

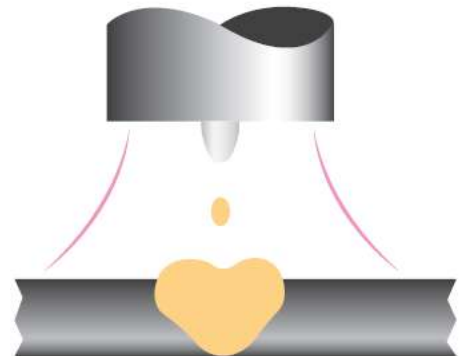

Welding Mode - Synergic

When a welding machine is referred to as synergic it means that when a single setting is adjusted (most commonly voltage or material thickness) other settings like current or wire speed also change.

There are current and voltage settings for all wire types, wire diameters and shielding gases.

The same current settings will have different wire feed speeds, workpiece material thickness and synergic voltages for different wire diameters.

After setting the current or wire feed speed and workpiece thickness, the system will have predetermined settings via it's software to match the welding voltage and the other welding parameters.

After choosing "synergic", the machine panel's left display will show preset current (wire feed speed or workpiece thickness dependent on the parameter selected). The right display will show the preset voltage.

The wire feeder control panel left display will show preset current and right display will show preset arc length. Both wire feed unit controls can both set current and voltage.

Standard arc length is "0"; adjustment is based on the synergic voltage plus or minus 3V.

GUIDE TO MIG/MAG WELDING



Before starting any welding activity ensure that you have suitable eye protection and protective clothing. Also take the necessary steps to protect any persons within the welding area.

Welding Mode - Manual (Standard)

Current or wire feed speed, workpiece thickness adjustment has no relation with voltage adjustment and other parameters. In this modes all required parameters are to be set as separate settings. Please see wire speed and voltage setting above.

Some quick reference handy tips for the MIG/MAG welding process are:

- When welding, try to use an electrode stick out (the distance between the weld and the contact tip) of around 6 - 8mm
- When welding thin materials try and use smaller MIG wire diameters and for thicker materials use thicker wires
- Make sure you select the correct MIG wire type for the material to be welded
- Ensure the MIG welding gun has the correct sized contact tip and type of liner
- Always ensure you have the correct size drive rolls and torch liner for the wire size selected
- Select the correct gas to achieve the correct weld characteristics and finish
- For optimum control of the weld keep the wire at the leading edge of the weld pool
- Before commencing welding, ensure a comfortable and stable position
- Try to keep the welding torch as straight as possible when welding to ensure the best feed
- Carry out daily housekeeping on the condition of the welding torch and drive rolls
- Keep any consumables clean and dry to avoid contamination such as oxidation and damp

Inductance

When MIG/MAG welding in the dip transfer mode the welding wire electrode touches the work piece/ weld pool and this results in a short circuit. When this short circuit occurs the arc voltage will fall to nearly zero. This change in the arc voltage will cause a change in the welding circuit.

The fall in voltage will cause a rise in the welding current. The size of the current rise is dependent upon the welding characteristic of the power source.

Should the power source respond immediately then the current in the circuit would rise to a very high value. The rapid increase in current would cause the short circuited welding wire to melt similar to an explosion creating a large amount of molten weld spatter.

By adding inductance to the weld circuit this will slow down the rate of current rise. It works by creating a magnetic field which opposes the welding current in the short circuit thereby slowing the rate of rise. If the inductance is increased it will cause an increase in arc time and reduction in the dip frequency, this will help reduce spatter.

Depending on the welding parameters there will be an optimum inductance setting for the best welding conditions. If the inductance is too low then there will be excessive spatter. If the inductance is too high the current will not rise high enough and the wire will stab the weld pool with insufficient heat.

The modern technology welding power sources often have the ability to provide the correct inductance to provide excellent weld characteristics. Many have a variable inductance control to give precise control.

GUIDE TO MIG/MAG WELDING



Before starting any welding activity ensure that you have suitable eye protection and protective clothing. Also take the necessary steps to protect any persons within the welding area.

Burn Back

In the event that the welder was to stop welding and all functions of the machine stopped simultaneously then the consumable filler wire would in all likelihood freeze in the weld pool. In order to avoid this happening the burn back feature is present on most machines.

This facility may be built in or an adjustable control. It will allow the power and gas shield to be maintained on the consumable filler wire when it has stopped feeding thereby burning clear of the weld. In some equipment the burn back is preset within the control circuits others offer an external variable control feature to adjust the time of delay.

Other Controls

Other common control features are latching or 2T/4T where the welding can either in 2T mode press the torch trigger to weld and release to stop or in 4T press and release the torch trigger to start, weld without holding the trigger on and stop by pressing and releasing the trigger again. This is particularly useful when carrying out long welding runs.

Crater fill controls are available on many machines. This allows the crater at the end to be filled helping eliminate welding defects.

A spot welding timer will allow the time of the weld to be set and after the time has expired the operator will have to release the torch switch to restart the weld.

MIG/MAG system checks

Shielding gas nozzle

This nozzle must be periodically cleaned to remove weld spatter. Replace if distorted or squashed.

Contact Tip

Only a good contact between this contact tip and the wire can ensure a stable arc and optimum current output; you must therefore observe the following precautions:

- The contact tip hole must be kept free of grime and oxidation (rust).
- Weld spatter sticks more easily after long welding sessions, blocking the wire flow, the tip must therefore be cleaned often and replaced if necessary.
- The contact tip must always be firmly screwed onto the torch body. The thermal cycles to which the torch is subjected can cause it to loosen, thus heating the torch body and tip and causing the wire to advance unevenly.

MIG Torch Wire Liner

This is an important part that must be checked often because the wire may deposit copper dust or tiny shavings. Clean it periodically along with the gas lines using dry compressed air. The liners are subjected to constant wear and tear and therefore must be replaced after a certain amount of time.

Wire Drive System

Periodically clean the set of feeder rollers to remove any rust or metal residue left by the coils. You must periodically check the entire wire feeder group: feed arms, wire guide rollers, liner and contact tip.

SPOOL GUN OPERATION



Before starting any welding activity ensure that you have suitable eye protection and protective clothing. Also take the necessary steps to protect any persons within the welding area.

Spool Gun Welding Mode

The Jasic Evolve 200 machines can both be used with our optional spool gun which is a Euro style spool gun that connects to the Evolve 200 MIG machines via the Euro outlet connector.

Connect the spool gun Euro plug to the (MIG) euro socket. Connect the spool gun 12 pin control plug to its matching 12 pin socket located on the front panel of the machine.

Ensure the link (located within the wire feed spool area) is connected into the “+” and ensure the locking screw tightened securely.

Insert the cable plug for the work clamp into the “-” socket on the front panel of the welding machine and tighten clockwise.

Connect the gas hose to the regulator/flowmeter located on the shield gas cylinder and connect the other end to the machine. After connecting the welding leads as detailed above you will need to switch the power switch on the back panel to “ON” and select MIG manual welding mode.

Set the welding voltage and other parameters via the machine control panel and when remote control function is enabled, the "Wire Feed Speed" is adjusted by the potentiometer on the spool torch handle.

Ensure you have adequate welding current according to the thickness of the work and weld prep being carried out.

Fit a 1Kg reel of welding wire to the spool holder and feed the wire through the drive rolls ensuring the fitted roller sizes matches your wire type and size, then continue to feed the wire through the contact tip again ensuring you have the correct size tip fitted.

Open the gas valve of the cylinder, press the torch trigger and adjust the gas regulator to obtain the desired flow rate.

Pressing the spool gun torch trigger will start the machine and welding can now be carried out. Adjust the “voltage” control knob on the front panel of the machine to set the correct welding voltage and adjust the “wire feed speed” control knob on the spool gun.

Please Note:

- The spool gun option can only be used in standard MIG welding mode, all other functions work as standard MIG torch. (Contact your supplier for the spool gun part number).
- MIG Synergic function is disabled when the control panel is set to spool gun.
- Wire feed speed control is carried out via the potentiometer control that is built into the spool gun torch.
- The spool gun and the control plug wiring is shown below via the 12pin control plug and socket, located on the front panel of the machine.

Optional Spool Gun

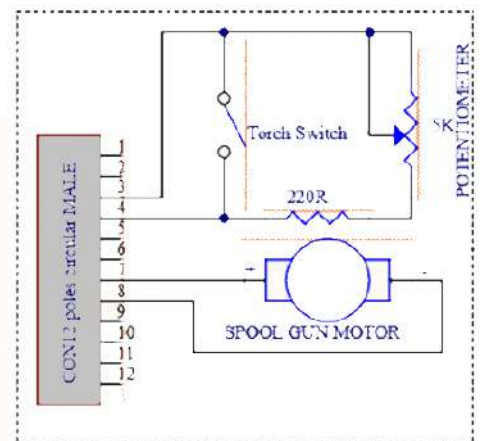
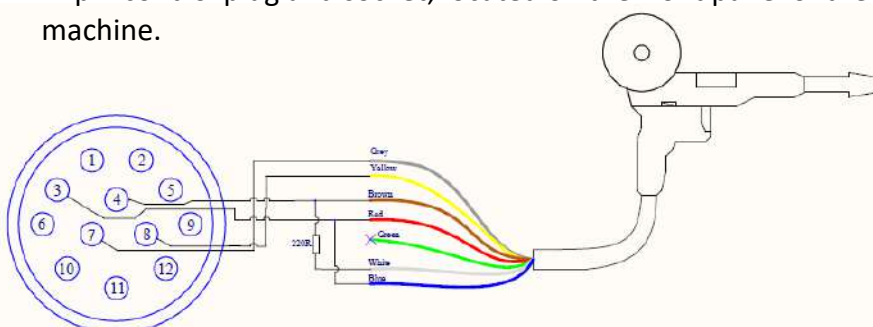

MANUAL MIG WELDING GUIDE

This information is intended to act as a starting point guide only for standard MIG mode.

EVOLVE 200 MIG Set-Up Guide

Set-Up Guide

Note: This set-up information is intended to act as a guide only. Please refer to operating manual for further information.

Material	Wire Type	Polarity	Shielding Gas (20-30 CFH Flow Rate)	Wire Dia.	0.5mm	0.6mm	0.8mm	1.0mm	1.2mm	1.6mm	3.0mm	4.5mm	6.0mm	6.0mm	8.0mm	10.0mm		
Steel	Solid Wire ER70S-6	DCEP	C25	0.6	15.5/3.2	15.5/3.6	16/4.3	16.5/5.6	17/6.4	17.5/7.8	18/9.7	18.5/10.5	-	-	-	-		
				0.8	15.5/2.3	15.5/2.4	16/2.8	16.5/3.8	17/5.1	17.5/5.7	18.5/6.4	19/7	19.5/7.9	19.5/7.9	20/8.9	21.5/10.5		
				1.0	15.5/1.8	15.5/2	16/2	16.5/2.8	17/3.6	17.5/4.2	18.5/4.5	19.5/5.1	20/10.5	20.5/7	21/7.6	-	-	
	Flux-Cored E71T-11	DCEN	-	0.6	16.5/3.2	16.5/3.6	17/4.3	18/5.6	18.5/6.4	19/8.6	19/8.6	19.5/9.9	20/10.5	-	-	-	-	-
				0.8	16.5/2.3	16.5/2.4	17/2.8	18/3.8	18.5/5.1	19/5.7	19.5/6.4	20/4.2	20/4.2	20.5/7	22/7.9	22/7.9	23.5/8.6	25/9.2
				1.0	16.5/1.8	16.5/2	17/2	18/2.8	18.5/3.6	20/4.2	21/4.1	21/4.1	22/6	22/6	22/6	22/6	23.5/7	24.5/8
				0.8	-	-	-	14/1.8	14.5/3.1	16/3.6	17.5/5.1	18.5/7.6	18.5/7.6	18.5/7.6	18.5/7.6	20/8.4	20.5/9.5	21/10.5
				1.0	-	-	-	-	14.5/1.8	15/2.3	17/3.6	18/4.1	18/4.1	18/4.1	18/4.1	19.5/5.6	20.5/6.6	21/7.1
				0.6	-	18/4.1	18.5/4.6	19/5.6	20/8.3	21.5/10.2	22/8.1	22/8.1	22/8.1	22/8.1	22/8.1	22/9.2	22/9.2	22.5/9.6
Stainless Steel	Tri-Mix	DCEP	-	0.8	-	18/2.7	18.5/3.0	19/3.8	19.5/4.1	20/5.1	21.5/6.6	22/8.1	22/9.2	22/9.2	22.5/9.6	23/10.2		
				1.0	-	18/2	18.5/2.2	18.5/2.8	19/3.1	19.5/4.1	21/4.8	21.5/5.6	22/6.1	22/6.1	22.5/6.6	23/7		
				0.8	-	-	-	13/7.6	14.5/10.2	20/8.9	21/9.3	21/9.3	21/9.3	21/9.3	-	-	-	
Aluminium	ER4043	DCEP	Argon	1.0	-	-	-	14.5/6.1	16/7.1	17/8.6	20/7.6	22/9.2	-	-	-	-		
				0.8	-	-	-	-	-	-	-	-	-	-	-	-	-	-

EVOLVE 200 MIG SET-UP GUIDE

Low carbon steel, stainless steel pulse MAG welding process reference							
Welding position	Material thickness (MM)	Wire diameter (MM)	Welding current (A)	Welding voltage (V)	Welding speed (CM/MIN)	Nozzle and workpiece spacing (MM)	Gas-flow rate (L/MIN)
Butt Joint	0.8	0.8	60-70	16-16.5	50-60	10-12	10
	1.0	0.8	75-85	17-17.5	50-60	11-13	10-15
	1.2	0.8	80-90	17-18	50-60	12-15	10-15
	1.6	1.0	80-100	19-21	40-50	12-15	10-15
	2.0	1.0	90-100	19-21	40-50	13-16	13-15
	3.2	1.2	150-170	22-25	40-50	14-17	15-17
	4.5	1.2	150-180	24-26	30-40	14-17	15-17
	6.0	1.2	270-300	28-31	60-70	17-22	18-22
	8.0	1.6	300-350	39-34	35-45	20-24	18-22
	10.0	1.6	330-380	30-36	35-45	20-24	18-22
Corner Joint	1.0	0.8	70-80	17-18	50-60	10-12	10-15
	1.2	1.0	85-90	18-19	50-60	11-13	10-15
	1.6	1.0/1.2	100-110	18-19.5	50-60	12-15	10-15
	1.6	1.0	90-130	21-25	40-50	13-16	10-15
	2.0	1.0	100-150	22-26	35-45	13-16	13-15
	3.2	1.2	160-200	23-26	40-50	13-17	13-15
	4.5	1.2	200-240	24-28	45-55	15-20	15-17
	6.0	1.2	270-300	28-31	60-70	18-22	18-22
	8.0	1.6	280-320	27-31	45-60	18-22	18-22
	10.0	1.6	330-380	30-36	40-55	20-24	18-22

Please Note:

The welding chart information above is intended to act as a starting point guide only for standard MIG welding.

EVOLVE 200 MIG SET-UP GUIDE

Welding process of aluminum alloy pulse MIG welding process reference							
Welding position	Material thickness (MM)	Wire diameter (MM)	Welding current (A)	Welding voltage (V)	Welding speed (CM/MIN)	Nozzle and workpiece spacing (MM)	Gas-flow rate (L/MIN)
Butt Joint	1.5	1.0	60-80	16-18	60-80	12-15	15-20
	2.0	1.0	70-80	17-18	40-50	15	15-20
	3.0	1.2	80-100	17-20	40-50	14-17	15-20
	4.0	1.2	90-120	18-21	40-50	14-17	15-20
	6.0	1.2	150-180	20-23	40-50	17-22	18-22
	4.0	1.2	160-210	22-25	60-90	15-20	19-20
	4.0	1.6	170-200	20-21	60-90	15-20	19-20
	6.0	1.2	200-230	24-27	40-50	17-22	20-24
	6.0	1.6	200-240	21-23	40-50	17-22	20-24
	8.0	1.6	240-270	24-27	45-55	17-22	20-24
	12.0	1.6	270-330	27-35	55-60	17-22	20-24
16.0	1.6	330-400	27-35	55-60	17-22	20-24	
Corner Joint	1.5	1.0	60-80	16-18	60-80	13-16	15-20
	2.0	1.0	100-150	22-26	35-45	13-16	15-20
	3.0	1.2	100-120	19-21	40-60	13-17	15-20
	4.0	1.2	120-150	20-22	50-70	15-20	15-20
	6.0	1.2	150-180	20-23	50-70	18-22	18-22
	4.0	1.2	180-210	21-24	35-50	18-22	16-18
	4.0	1.6	180-210	18-20	35-45	18-22	18-22
	6.0	1.2	220-250	24-25	50-60	18-22	16-24
	6.0	1.6	220-240	20-24	37-50	18-22	16-24
	8.0	1.6	250-300	25-26	60-65	18-22	16-24
	12.0	1.6	300-400	26-28	65-75	18-22	16-24

Please Note:

The welding chart information above is intended to act as a starting point guide only for standard MIG welding.

MIG WELDING PROBLEMS



Before starting any welding activity ensure that you have suitable eye protection and protective clothing. Also take the necessary steps to protect any persons within the welding area.

MIG welding defects and prevention methods

<u>Defect</u>	<u>Possible cause</u>	<u>Action</u>
Porosity (within or outside the bead)	Poor material	Check the material is clean
	Insufficient shield gas flow	Check hoses and MIG torch for blockages
	Gas flow too low/high	Check the regulator setting or that it is not frozen due to a high flow
	Leaking hoses	Check all hoses for leaks
	Faulty gas valve	Call a service engineer
	Working in open area with drafts	Put screens up around the weld area
Poor or inconsistent wire feed	Incorrect pressure on wire drive causing burn back to contact tip or bird nesting at the feed roll	Readjust the upper feed pressure Increase the pressure to eliminate burn back to tip Decrease pressure to eliminate bird nesting
	Damage to torch liner	Replace torch liner
	Welding wire contaminated or rusty	Replace wire
	Worn welding tip	Check and replace welding tip
No operation when the torch switch is operated	Torch switch faulty	Check the torch switch continuity and replace if faulty
	Fuse blown	Check fuses and replace if necessary
	Faulty PCB inside the equipment	Call a service engineer
Low output current	Loose or defective work clamp	Tighten/replace clamp
	Loose cable plug	Re-fix plug
	Power source faulty	Call a service engineer
No operation	No operation and mains lamp not lit	Check mains fuse and replace if required
	Faulty power source	Call a service engineer
Excessive spatter	Wire feed speed too high or welding voltage too low	Reset the parameters according to the weld to be made
Excessive penetration, the weld metal is below the surface level of the material and hangs below	Heat input too high	Reduce the amperage or use a smaller electrode and lower amperage
	Poor weld technique	Use correct welding travel speed

MIG WELDING PROBLEMS



Before starting any welding activity ensure that you have suitable eye protection and protective clothing. Also take the necessary steps to protect any persons within the welding area.

MIG welding defects and prevention methods

<u>Defect</u>	<u>Possible cause</u>	<u>Action</u>
Burning through – Holes within the material where no weld exists	Heat input too high	Use lower amperage or smaller electrode Use correct welding travel speed
Poor fusion – Failing of weld material to fuse either with the material to be welded or previous weld beads	Insufficient heat level	Increase the amperage or increase the electrode size and amperage
	Poor welding technique	Joint design must allow for full access to the root of the weld Alter welding technique to ensure penetration such as weaving, arc positioning or stringer bead technique
	Work piece dirty	Remove all contaminant from the material i.e. oil, grease, rust, moisture prior to welding
Irregular weld bead and shape	Incorrect voltage/wire feed settings If it's convex, voltage is too low and if it's concave then voltage is too high.	Adjust voltage and/or wire feed speed
	Insufficient or excessive heat input	Adjust the wire feed speed dial or the voltage control
	Wire is wandering	Replace contact tip
	Incorrect shielding gas	Check and change the shielding gas as required
Your weld is cracking	The weld beads too small	Try decreasing the travel speed
	Weld penetration narrow and deep	Try reducing the wire feed speed current and voltage or increase MIG torch travel speed
	Excessive voltage	Decrease voltage control dial
	Weld/material cooling rate too fast	Slow the cooling rate by preheating part to be welded or cool slowly
The welding arc does not have a crisp sound that short arc exhibits when the wire feed speed or voltage are adjusted correctly.	The MIG torch may have been connected to the wrong output voltage polarity on the front panel	Ensure that the MIG torch polarity lead is connected to the positive (+) welding terminal for solid wires and gas shielded flux cored wires

MIG TORCH SPARE PARTS LIST

MIG Welding Torch - Air Cooled 300A - Model: HC300-3E

Hard Core HC300 Rating 300A Co2 / 220A Mixed Gases @ 60% Duty Cycle EN60974-7 Wire Size 0.6mm to 1.4mm



PLEASE NOTE:

Check torch supplied with your package to ensure it matches this page details.



HARD CORE 300A TORCH AIR COOLED

MIG Welding Torch Model: HC300

Rating 300A Co2/220A Mixed Gases @ 60% Duty Cycle EN60974-7 Wire Sizes 0.6-1.4mm

Torch Packages		
HC300-3E	HC300-4E	HC300-5E
3 metre	4 metre	5 metre
*Euro Fitting and Bladeswitch		

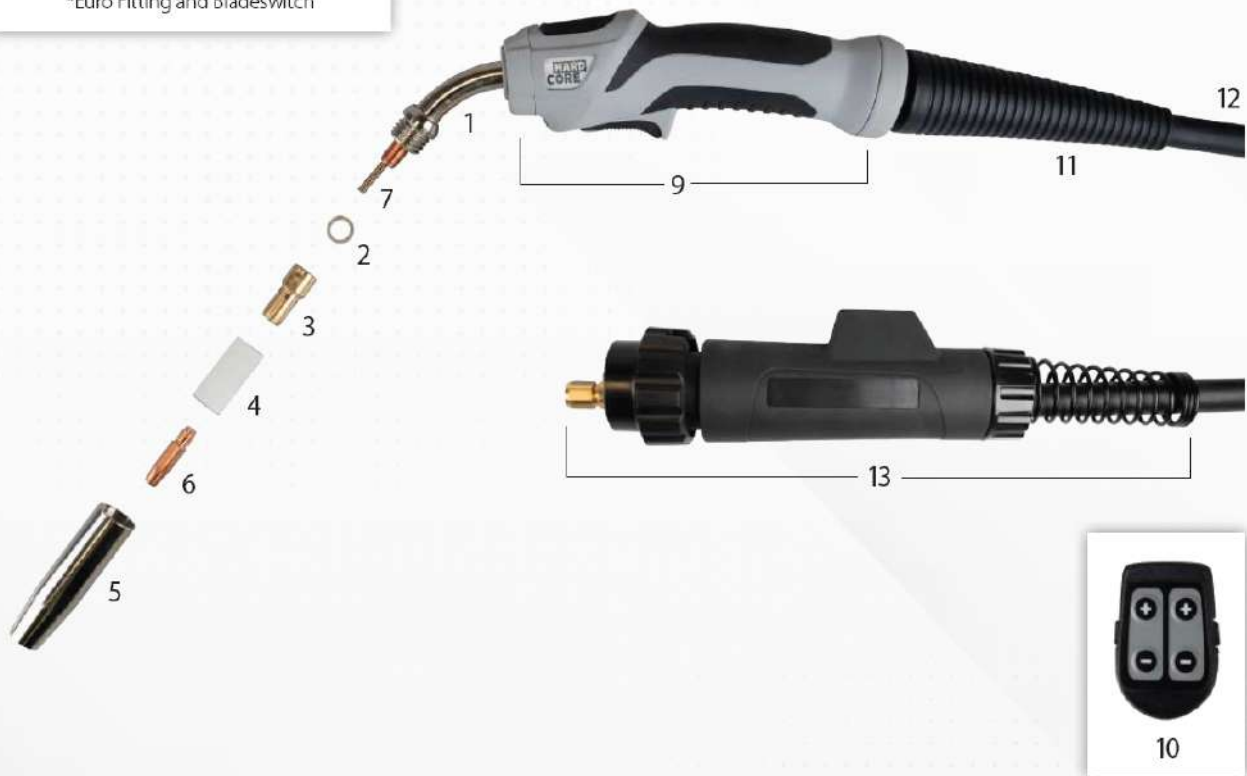

MAIN CONSUMABLES

Code	Description	Pack Qty
1	HC3001 Swan Neck 45°	1
2	HC3002 Neck Washer	10
3	HC3003 Gas Diffuser M8	5
4	HC3004 Nozzle Insulator	5
5	HC3005 Conical Nozzle	5
	HC3007 Cylindrical Nozzle	5

CONTACT TIPS (M8 X 33MM HEXAGONAL)

6	HC3006 0.6mm Steel	25
	HC3008 0.8mm Steel	25
	HC3010 1.0mm Steel/0.8mm Alu	25
	HC3012 1.2mm Steel/1.0mm Alu	25
	HC3014 1.4mm Steel/1.2mm Alu	25

LINERS (STEEL)

7	HC3300 0.8-1.2mm 3M Blue	1
	HC3400 0.8-1.2mm 4M Blue	1
	HC3500 0.8-1.2mm 5M Blue	1
	HC3301 1.2-1.4mm 3M Grey	1
	HC3401 1.2-1.4mm 4M Grey	1
	HC3501 1.2-1.4mm 5M Grey	1

LINERS (ALUMINIUM)

Code	Description	Pack Qty
8	HC4300 0.8-1.0mm 3M Black	1
	HC4400 0.8-1.0mm 4M Black	1
	HC4500 0.8-1.0mm 5M Black	1
	HC4301 1.0-1.2mm 3M Blue	1
	HC4401 1.0-1.2mm 4M Blue	1
	HC4501 1.0-1.2mm 5M Blue	1
	HC4302 1.6mm 3M Red	1
	HC4402 1.6mm 4M Red	1
	HC4502 1.6mm 5M Red	1

SECONDARY CONSUMABLES

9	HC3017 Torch Handle Kit	1
10	HC48CM 4 Button Control Module	1
	HC3018 Cable Support	1
	HC3019 Cable Assy 3M	1
	HC3020 Cable Assy 4M	1
	HC3021 Cable Assy 5M	1
13	HC3022 Torch Back End Kit	1

* Torch Handle Kit Comprises Handle Sheets, Trigger, Front & Rear Lock Nuts, Blanking Plate

* Torch Back End Kit Comprises Gun Plug Body, Gun Plug Housing, Gun Plug Nut, Locking Nut

REMOTE CONTROL SOCKET



Before starting any welding activity please ensure that you have suitable eye protection and protective clothing. Always take the necessary steps to protect any persons within the welding area.

Remote torch control

The 2 pin remote control socket located on the front panel is used to connect a TIG torch trigger switch control plug.

Pin	Description TIG	Description MMA
1	Torch switch	N/A
2	Torch switch	N/A

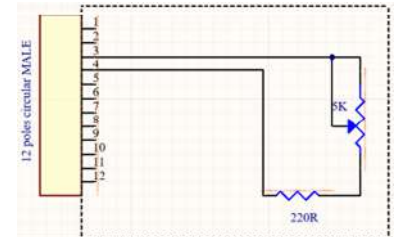

Remote amperage control

Remote current control can be used in TIG and MMA mode although this is carried out via the 12pin control plug, as shown right.

TIG torch remote amperage control

Connect the TIG torch control plugs to the machines 2 pin and 12 pin remote sockets and place the machine torch trigger mode into 4T. Press the TIG torch switch to start the machine output functions.

The finger controlled torch handle mounted current potentiometer controls the welding amperage (by rotating clockwise/anti clockwise) up to the already pre-set level set on the welding power source control panel.

With a TIG torch current control connected, the machines digital ammeter will display the pre-set preview amps until the torch switch is pressed, when welding commences it will then display actual welding current depending on where your torch mounted potentiometer is positioned.

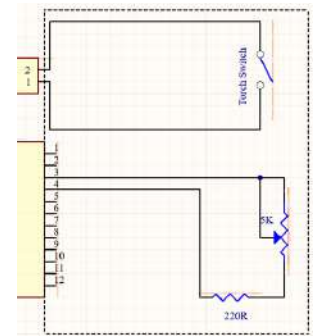

Foot pedal amperage control

Connect the TIG torch control plugs to the machines 2 pin and 12 pin remote sockets and place the machine torch trigger mode into 2T. Press the foot pedal down to start the machine output functions.

The foot control potentiometer controls the welding current up to the preset level set on the welding power source control panel.

Please note:

The maximum output current must be set on the power source control panel by the user prior to the foot control being connected.

With the foot control connected, the panel digital ammeter will display the pre-set preview amps until the foot control is depressed then it displays actual welding current when welding.

Pressing the foot pedal increases the welding current; letting up on the foot pedal decreases the welding current and releasing the pedal completely will extinguish the arc which in turn will initiate the post flow shielding gas time.

Please Note: With a foot pedal connected ensure pre-set upslope/downslope settings are set to zero.

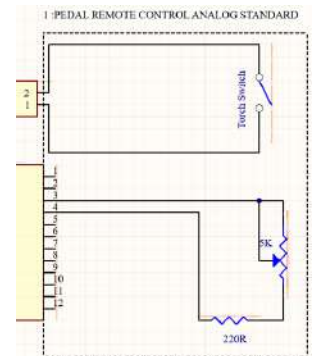

REMOTE CONTROL



Before starting any welding activity please ensure that you have suitable eye protection and protective clothing. Always take the necessary steps to protect any persons within the welding area.

Remote control application and function

- 1) Any type of TIG torch switch can be connected to the 2 pin remote socket. Trigger action can be chosen between 2T, 4T and Spot. The current is adjustable via control panel dial and the orange bar graphic indicates the graphic level external analog control with 5Kohm potentiometer connected to the CAD connector which can adjust the welding current, the current bar graph change into double indication with two colours, the yellow bar graph indicates the maximum set current and its digital values are reported only during the adjustment by the front panel knob with digits that change colour into yellow the adjustment from the connected analog control is shown with a orange bar graph and digital mode over the digits in white colour (Note: the analog control can be also the foot control without the switch connected).
- 2) Any type of analog torch (as TER configuration), the cycle can be chosen between 2T, 4T and Spot, the current set is adjustable by panel knob and orange bar graph indicates the graphic level the current set can be adjustable also by the push buttons of the analog torch in parallel to the knob of the front panel the adjustment from the torch can be used also in welding mode when the torch cycle is set at 4T external analog control with 5Kohm potentiometer connected to the CAD connector can modulate the welding current, the current bar graph change into double indication with two colours, the yellow bar graph indicates the maximum set current and its digital values is reported only during the adjustment by the front panel knob with digits that change colour into yellow the adjustment from the connected analog control is shown with a orange bar graph and digital mode over the digits in white colour (note that the analog control can be also the foot control without the switch connected).
- 3) Evolve Smart torch connected to the two pole torch switch the Cycle can be chosen between 2T, 4T and Spot also from the torch the current set is adjustable by panel knob and orange bar graph indicates the graphic level, the same adjustment can be done also from the smart control of the torch external analog control with 5Kohm potentiometer connected to the CAD connector can modulate the welding current, the current bar graph change into double indication with two colours, the yellow bar graph indicates the maximum set current level and its digital values is reported only during the adjustment by the front panel knob with digits that change colour into yellow the adjustment from the smart torch is for maximum set (as for the knob), can be checked in the smart module as value, but in the front display only the yellow bar graph indicates the changes, the digits show in white colour the set from remote control. the adjustment from the connected analog control is shown with a orange bar graph and digital over the digits in white colour (note that the analog control can be also the foot control without the switch connected).

Digital TIG Torch trigger upgrade for TIG-110

Button	Action
Top Button	Torch Trigger
Bottom Button	N/A
Left Button	Decrease Current (-)
Right Button	Increase Current (+)



4 button trigger module shown

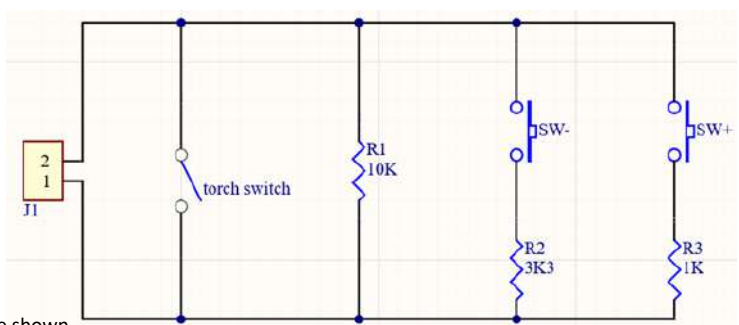

OPERATION - DIGITAL MIG TORCH

Digital MIG Torch Operation Option

The Evolve 200 can be operated with the premium range of Starparts Hard Core MIG torches which offers the operator the ability to operate certain MIG functions from the MIG torch handle, this optional 4 button torch handle control module (shown right).

The 4 button control module Pt No HC4BCM clips into place on the HC300, the Hard Core 300A Air Cooled Mig Torch which is available in 3m, 4m or 5m lengths. The Hard Core MIG torch range is pre-wired to accept the 4 button control module and once clipped into place will allow the operator to control a number of MIG functions on the Jasic Evolve plus machine.

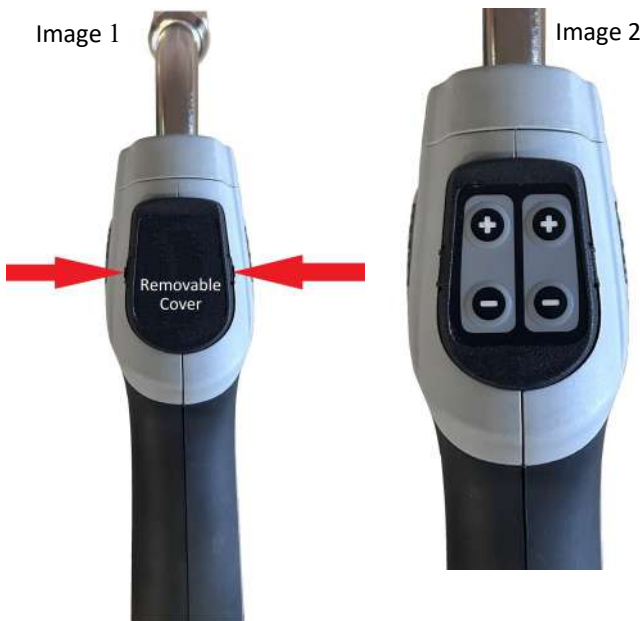

Fitting the 4 button control module is simple, first remove the black plastic cover by pressing in either side of the cover (as shown with the red arrows in image 1 left) and then pulling the cover away. Now offer the 4 pin control module to the torch handle and push fit in into place, you will note that it does clip into place as shown left in image 2.

Please Note:

The optional 4 button control module is only designed to be used with the Jasic Evolve and the EVO range of machines.

In Standard MIG mode:



- A - Increases wire feed speed.
- B - Decreases wire feed speed.
- C - Increases welding voltage.
- D - Decreases welding voltage.

1. Using buttons A or B will increase or decrease your wire feed speed.
2. Using buttons C or D will increase or decrease your welding voltage.

In Synergic/Pulse MIG mode:



- A - Increases welding amperage.
- B - Decreases welding amperage.
- C - Increases welding voltage.
- D - Decreases welding voltage.

1. Using buttons A or B will increase or decrease your welding amps, if wire feed speed or material thickness is displayed in the top display, you will also see these values increase or decrease. Welding voltage will also increase and decrease as well.
2. Using buttons C and D will increase or decrease your welding voltage only.

APP REMOTE CONTROL



Before starting any welding activity please ensure that you have suitable eye protection and protective clothing. Always take the necessary steps to protect any persons within the welding area.

App remote control

The EVOLVE 200 machine can be controlled via the JTE Cloud app where it is possible to set and adjust various welding control parameters with your mobile. Various remote controls details will be shown via the app on your mobile phone screen.

The App is available in the App store for IOS, and in the Play store for Android. Download and install the App mobile in your mobile, and follow the instructions. The connection from mobile to the Evolve 200 machine can be through your local Wi-Fi network or via you Bluetooth connection*.



First, ensure you have your Evolve machine powered up and connected to your local wi-fi network. If wi-fi is not available then the app will use bluetooth to facilitate the connection as Bluetooth is always active on the Evolve machine.

Once you have downloaded and opened up the app, you need to accept (A) as the image shows below and allow the JTE app to use the phones bluetooth connection.

The app will then give you a quick tutorial (B) where you have to press the screen button at each stage to progress through the lesson screens.

Once the tutorial has finished you will see three options for connecting to the machine, press the bottom function 'Search for Available Machine' and the will search for the machine.

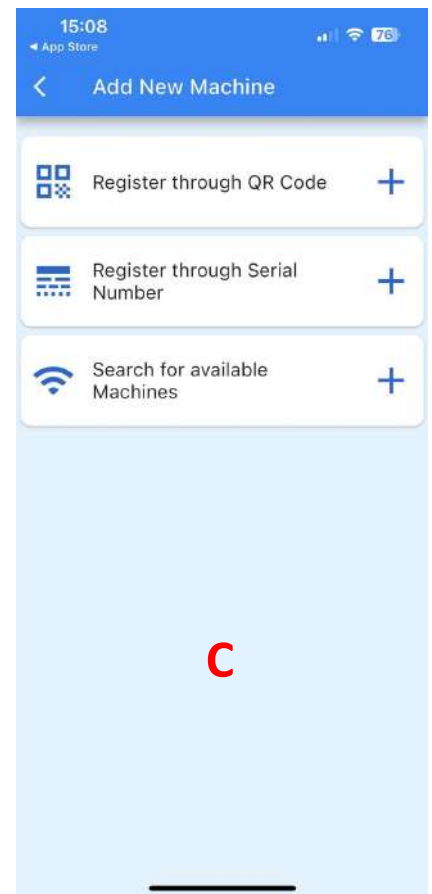
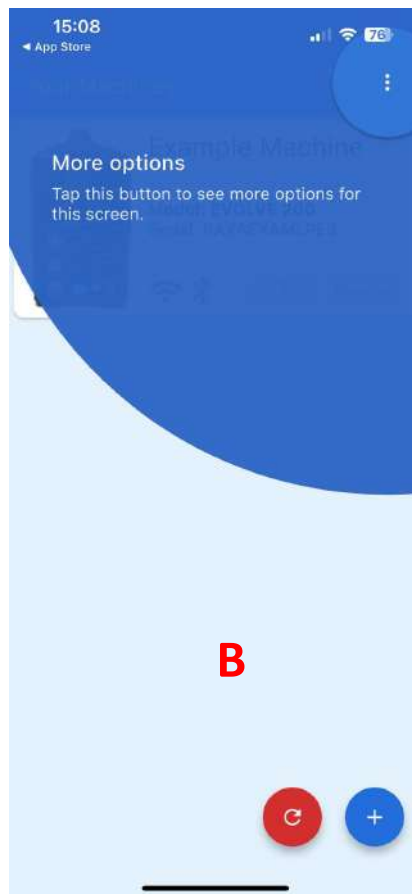
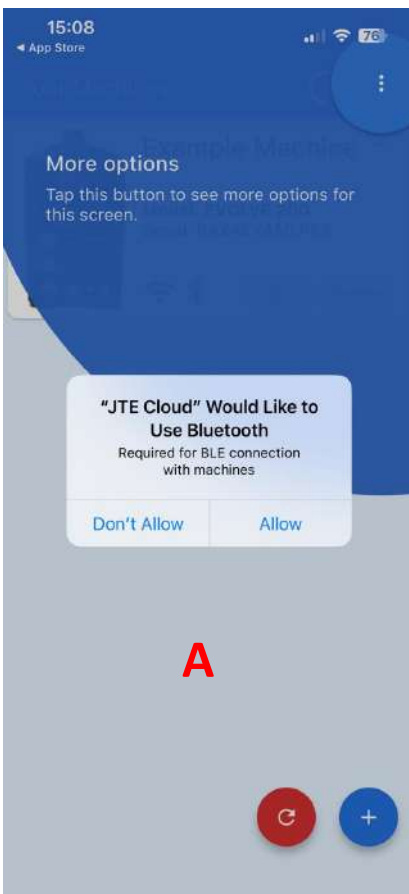

Please Note

Only 1 Evolve machine can be active with the app at any one time.

* If you do not accept this option of bluetooth connection, then you have to ensure that wi-fi is available in the area where the machine is located.

APP REMOTE CONTROL



Before starting any welding activity please ensure that you have suitable eye protection and protective clothing. Always take the necessary steps to protect any persons within the welding area.

App remote control (continued)

Once the JTE App finished and following pressing the bottom function 'Search for Available Machine' as shown on the previous page, the app will search for the machine as image 'D' shows below.

Once the app has discovered your machine as shown in image 'E' below the details of that machine, including the model number and it's serial number will be shown as confirmation.

Pressing the 'Remote' tab will then start the process of connecting the app to the chosen machine as shown in image F below.

Please Note, If you have more than 1 Evolve product and you wish to add a second Evolve machine to the app, you will note that at the bottom of the screen (as seen in image E) the plus  icon, which allows you to add further Jasic Evolve products going forward to the app.



Once the JTE cloud app is fully connected to your Evolve 200 machine, your mobile phone screen will show the current welding mode that the Evolve machine is presently in.

The image left is the JTE app now connected to the machine and you will note that the details on the app match the Evolve machine screen image as in the image shown right.

If, for example you change the welding

current via the JTE app or via the Evolve user screen, the app and machine will sync and update almost immediately and display the updated welding data.

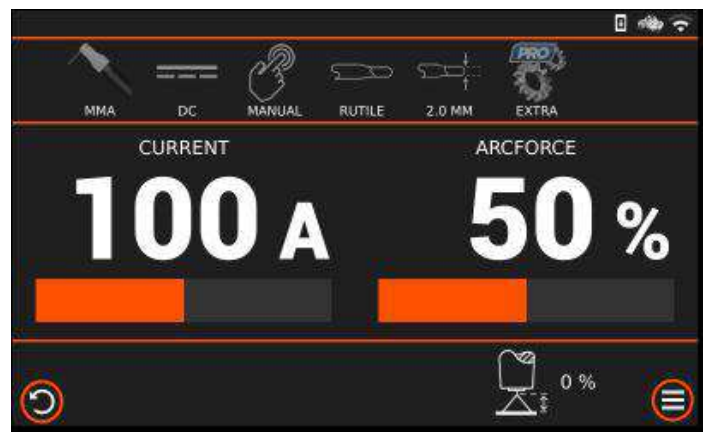

APP REMOTE CONTROL



Before starting any welding activity please ensure that you have suitable eye protection and protective clothing. Always take the necessary steps to protect any persons within the welding area.

App remote control (Continued)

The JTE cloud app will not change between welding modes i.e. from MMA mode to TIG mode, this operation can only be carried out via the Evolve user screen.

If you change the welding mode on the machine from MMA to TIG mode, the JTE app screen will sync and instantly change to show TIG mode as shown in image (G) right and the TIG setup details will be shown.

From here you can select and change various TIG welding parameters, for example if you press the DC Pulse tab a drop down menu will open up where you can select the various pulse options, including DC, DC Pulse or DC Pulse MIX, pressing an alternative will save your selection and return you to the main screen.

If you swipe the app screen left, you will then enter further TIG welding parameters as shown in image (H) right. From here, pressing each available TIG parameter will allow you to adjust the chosen TIG parameter.

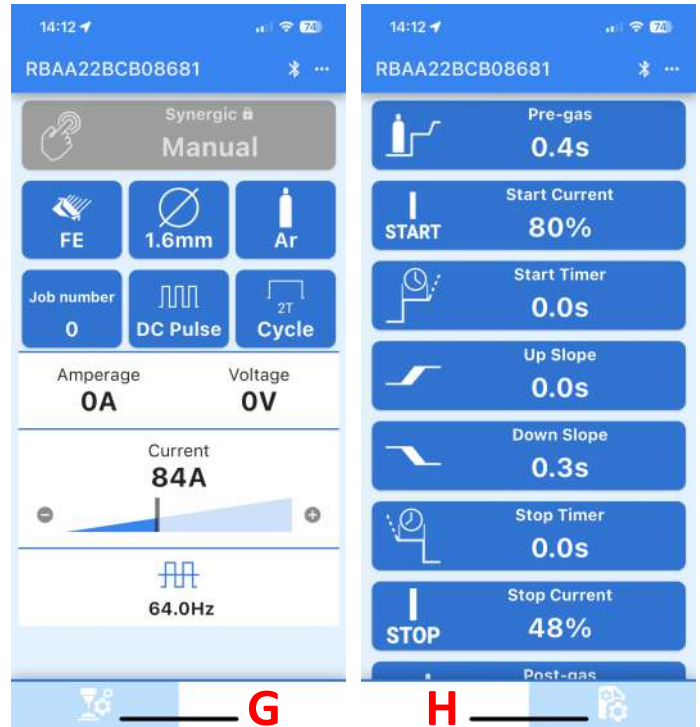
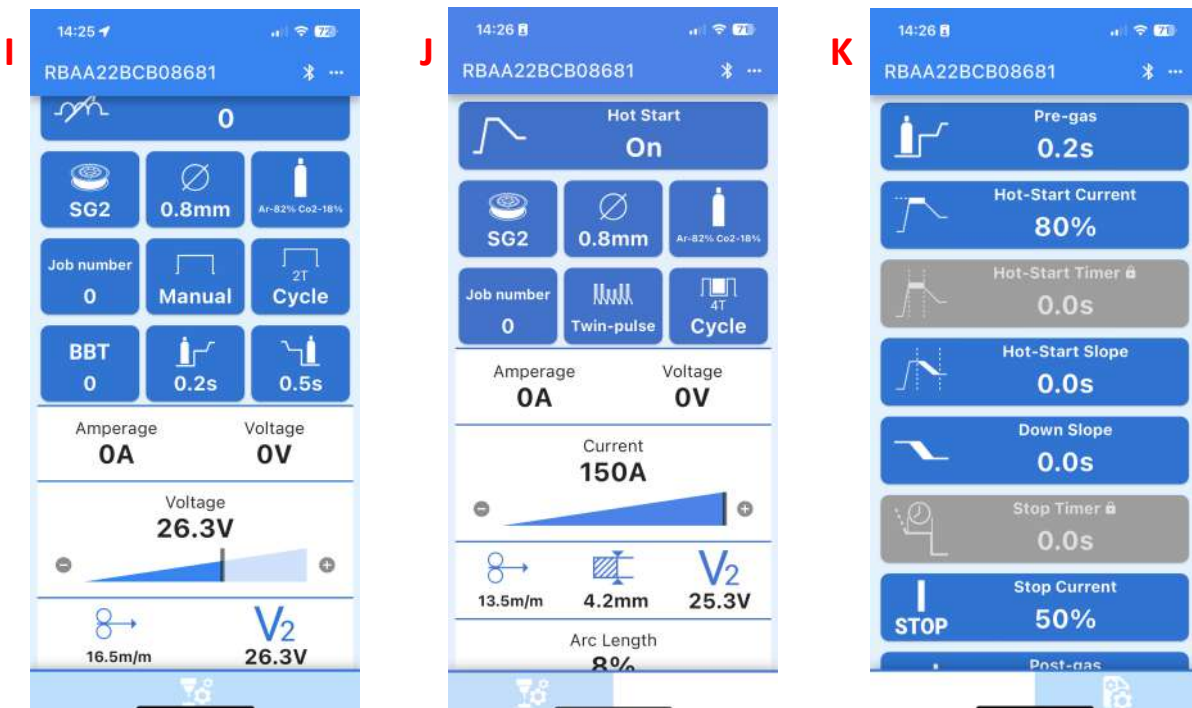

Image (I) below, shows that the machine welding mode is now in manual MIG mode which the app screen has replicated. If you press the 'Manual' icon you will see a drop down menu where you can select the various MIG mode options, if you press 'twin-pulse' as image (J) shows, the machine is now in Double (twin) Pulse MIG mode. Swiping the screen left will open up the secondary screen (K) as shown below that offer various other parameters available for double pulse. Scrolling down will show further parameters that are off screen and out of view.



MAINTENANCE



The following operation requires sufficient professional knowledge on electric aspects and comprehensive safety knowledge. Make sure the input cable of the machine is disconnected from the electricity supply and wait for 5 minutes before removing the machine covers.

In order to guarantee that the arc welding machine works efficiently and in safety, it must be maintained regularly. Operators should understand the maintenance methods and means of arc welding machine operation. This guide should enable customers to carry out simple examination and safeguarding by oneself, try to reduce the fault rate and repair times of the arc welding machine, so as to lengthen service life of arc welding machines.

<u>Period</u>	<u>Maintenance item</u>
Daily examination	Check the condition of the machine, mains cables, welding cables and connections. Check for any warnings LEDs and machine operation.
Monthly examination	Disconnect from the mains supply and wait for at least 5 minutes before removing the cover. Check internal connections and tighten if required. Clean the inside of the machine with a soft brush and vacuum cleaner. Take care not to remove any cables or cause damage to components. Ensure that ventilation grills are clear. Carefully replace the covers and test the unit. This work should be carried out by a suitably qualified competent person.
Yearly examination	Carry out an annual service to include a safety check in accordance with the manufacturers standard (EN 60974-1). This work should be carried out by a suitably qualified competent person.

TROUBLESHOOTING

Before arc welding machines are dispatched from the factory, they have already been checked thoroughly. The machine should not be tampered with or altered. Maintenance must be carried out carefully. If any wire becomes loose or is misplaced, it maybe potentially dangerous to user! Only professional maintenance personnel should repair the machine!

<u>Description of fault</u>	<u>Possible cause</u>	<u>Action</u>
The welding arc cannot be established	Power switch has not been switched ON Incoming mains power supply is not ON Possible internal power failure	Switch ON power switch Check incoming power switch for correct operation and supply Have a technician check the machine and mains power supply
Difficult arc ignition	Low arc current	Increase the arc current setting Check condition of the MMA welding leads
Overheat Error lit	Machine operated outside duty cycle Fan not working	Allow the machine to cool and the unit will reset automatically Have a technician check for obstructions blocking the fan
Over current Error lit	Mains supply problem	Have a technician check the mains supply

TROUBLESHOOTING - ERROR CODES



The following operation requires sufficient professional knowledge on electric aspects and comprehensive safety knowledge. Make sure the input cable of the machine is disconnected from the electricity supply and wait for 5 minutes before removing any machine covers.

The control display is also used for providing error messages to the user, if an error message is displayed, the power source may only function to a limited capacity and the cause of the error should be checked as soon as possible.

The below is a list of error codes for the Jasic Evolve range of welding machines, so some error codes may not be applicable for certain models.

Error Code	Error Meaning	Error Description	Recommended Action	Possible Cause
1	Exceeding internal voltage limits.	Critical supply voltage in the main control board.	Restart the machine. If the problem still exists then contact the service centre.	The main control board fault.
2	Backup voltage failure.	Backup voltage failure.	Restart the machine. If the problem still exists then contact the service centre.	Low battery.
3	High CPU temperature.	The CPU temperature is too high.	Power off the machine and wait a few minutes to cool down the CPU. If the problem still exists then contact the service centre.	High ambient temperature.
10	Error in the unique identifier.	Error in the unique identifier.	Restart the machine. If the problem still exists then contact the service centre.	Fault in the main control PC Board. Bad electrical connection.
11	Alarm 24V.	The power supply outside the limits of 24V DC.	Restart the machine. If the problem still exists then contact the service centre.	Control PC board fault. Supply PC board fault.
12	Alarm 5V.	The power supply outside the limits of 5V DC.	Restart the machine. If the problem still exists then contact the service centre.	Control PC board fault. Supply PC board fault.
13	Alarm -15V.	The power supply outside the limits of -15V DC.	Restart the machine. If the problem still exists then contact the service centre.	Control PC board fault. Supply PC board fault.
14	Alarm +15V.	The power supply outside the limits of +15V DC.	Restart the machine. If the problem still exists then contact the service centre.	Control PC board fault. Supply PC board fault.
15	Hall sensor.	Anomaly in the read out in the output current.	Restart the machine. If the problem still exists then contact the service centre.	Poor electrical connection. Fault in the main control board.
17	Internal memory failure.	Memory anomaly.	Restart the machine. If the problem still exists then contact the service centre.	Problem with the machine firmware.
18	Error in DC bus voltage.	Main inverter supply voltage anomaly.	Restart the machine. If the problem still exists then contact the service centre.	Main power supply board fault.
20	High probe voltage.	Output voltage anomaly.	Restart the machine. If the problem still exists then contact the service centre.	Main power supply fault Fault in the main control board.
21	Unknown function.	Selected program is not available.	Contact your dealer or login to the JTE cloud to add additional welding programs.	N/A
22	Front panel display error.	Front panel error.	Restart the machine. If the problem still exists then contact the service centre.	Control PC board fault. Front panel fault.

TROUBLESHOOTING - ERROR CODES



The following operation requires sufficient professional knowledge on electric aspects and comprehensive safety knowledge. Make sure the input cable of the machine is disconnected from the electricity supply and wait for 5 minutes before removing any machine covers.

The control display is also used for providing error messages to the user, if an error message is displayed, the power source may only function to a limited capacity and the cause of the error should be checked as soon as possible.

The below is a list of error codes for the Jasic Evolve range of welding machines, so some error codes may not be applicable for certain models.

Error Code	Error Meaning	Error Description	Recommended action	Possible Cause
23	Analogue to digital converter error.	Internal error in the control PC board.	Restart the machine. If the problem still exists then contact the service centre.	Control PC board fault.
30	Torch in short circuit.	Torch in short circuit.	Check the output connections make sure the torch doesn't touch the work desk or the negative cabling.	Torch connected on the working desk. There is problem with grounding connection or wire.
40	Inverter temperature error.	Temperature sensor ntc1. Inverter rose heat max temperature.	Turn off the machine and wait a few moments until the inverter arrived at the stable temperature. If the problem still exists then contact the service centre.	Fault in the inverter temperature sensor. The inverter temperature sensor is disconnected.
41	P & P connector temperature.	Error in the Plug & Play temperature sensor NTC 2.	Restart the machine. If the problem still exists then contact the service centre.	Fault in the Plug and Play temperature sensor. The sensor is disconnected. Fault in the cooling system.
42	Temperature sensor -1.	Temperature sensor 1 error.	Wait a few moments until the alarm disappears. Check the cooling fan. If the problem still exists then contact the service centre.	Overheating fault cooling system.
43	Temperature sensor -2.	Temperature sensor 2 error.	Wait a few moments until the alarm disappears. Check the cooling fan. If the problem still exists then contact the service centre.	Control PC board fault.
44	High inverter temperature.	Inverter overheating.	Wait a few moments until the alarm disappears. Check the cooling fan. If the problem still exists then contact the service centre.	Fault cooling system.
45	High Plug and Play temperature.	Plug and Play connector overheating please wait the cooling down time.	Wait a few minutes until the alarm disappears. Check the cooling fan. If the problem still exists then contact the service centre.	Overworking.
50	Power frequency error.	The frequency of the input voltage is out of tolerance (50/60hz).	Restart the machine. If the problem still exists then contact the service centre.	Wrong power supply network.
51	Low voltage.	The power supply voltage is below the minimum input voltage.	Restart the machine. If the problem still exists then contact the service centre.	Check the power supply input resource. Fault in the main control board.

TROUBLESHOOTING - ERROR CODES



The following operation requires sufficient professional knowledge on electric aspects and comprehensive safety knowledge. Make sure the input cable of the machine is disconnected from the electricity supply and wait for 5 minutes before removing any machine covers.

The control display is also used for providing error messages to the user, if an error message is displayed, the power source may only function to a limited capacity and the cause of the error should be checked as soon as possible.

The below is a list of error codes for the Jasic Evolve range of welding machines, so some error codes may not be applicable for certain models.

Error Code	Error Meaning	Error Description	Recommended action	Possible Cause
52	High voltage.	The power supply voltage is above the maximum input voltage.	Restart the machine. If the problem still exists then contact the service centre.	Check the power supply input resource. Fault in the main control board.
53	Undefined voltage.	The power supply voltage is undefined.	Restart the machine. If the problem still exists then contact the service centre.	N/A
54	Missing phase.	Missing a phase in the power supply voltage.	Restart the machine. If the problem still exists then contact the service centre.	N/A
55	Unknown voltage error.	Wrong power supply connection.	Restart the machine. If the problem still exists then contact the service centre.	N/A
60	Pre-load error.	Start-up control failure.	Restart the machine. If the problem still exists then contact the service centre.	N/A
61	PWM inverter error.	Start-up inverter control failure.	Restart the machine. If the problem still exists then contact the service centre.	Fault in the power inverter.
62	Wire feeder motor error.	Error in the wire feeder motor power supply.	Restart the machine. If the problem still exists then contact the service centre.	Wire feeder is not connected to power source or poor connection in circuit.
63	PWM wire feeder motor error.	Power supply anomaly of the wire feeder motor.	Restart the machine. If the problem still exists then contact the service centre.	Error in the communication with the main machine.
64	Wire feeder motor voltage error.	Over-current in the wire feeder motor.	Restart the machine. If the problem still exists then contact the service centre.	Error in the communication with the main machine.
65	Plug & Play communication error 485.	Communication error with connected Plug & Play module.	Restart the machine. If the problem still exists then contact the service centre.	Connection problem with the machine. Broken or damage Plug & Play module connector. Fault in the Plug & Play module PC control board.
66	Hardware error.	Hardware error in the power inverter.	Restart the machine. If the problem still exists then contact the service centre.	N/A
67	Invalid calibration.	Out of range of the calibration data.	Restart the machine. If the problem still exists then contact the service centre.	Error during the calibration process.

TROUBLESHOOTING - ERROR CODES



The following operation requires sufficient professional knowledge on electric aspects and comprehensive safety knowledge. Make sure the input cable of the machine is disconnected from the electricity supply and wait for 5 minutes before removing any machine covers.

The control display is also used for providing error messages to the user, if an error message is displayed, the power source may only function to a limited capacity and the cause of the error should be checked as soon as possible.

The below is a list of error codes for the Jasic Evolve range of welding machines, so some error codes may not be applicable for certain models.

Error Code	Error Meaning	Error Description	Recommended action	Possible Cause
68	Alarm PWM PFC.	Error in the (PFC) power factor control driver.	Restart the machine. If the problem still exists then contact the service centre.	Note: applicable for the 3ph models only
70	Internal thermal cycle error.	Error in the internal thermal cycle. Max power limit exceeded.	Restart the machine. If the problem still exists then contact the service centre.	N/A
71	External thermal cycle error.	Welding time limit exceeded. Thermal cycle limit exceeded.	Wait a few moments for thermal overload to cool down.	All welding machines are (or should be) fitted with thermal overload protection which means the machine will cut out when external critical components reach a certain temperature, to prevent damage. The machine will then restart when it returns to a safe temperature.
72	Wire feeder motor speed error.	The wire feeder motor speed is out of the limits.	Check torch consumable parts, pressure of the rolls.	Torch quality. Bad motor fixing rolls.
73	Wire feeder motor encoder error.	Missing feedback from the motor speed sensor.	Restart the machine. If the problem still exists then contact the service centre.	Fault of the control board. Fault of the speed sensor.
74	Wire feeder motor wrong direction alarm.	The wire feeder motor is rotating in the wrong direction.	Restart the machine. If the problem still exists then contact the service centre.	Wire feed motor incorrectly wired
75	Short circuit in MIG.	Short circuit in MIG mode.	Check the output connections make sure the torch doesn't touch the work desk or the negative cabling.	N/A
76	Wire feeder motor braking error.	Wire feeder motor's brake isn't working properly.	Restart the machine. If the problem still exists then contact the service centre.	Fault control PC board
80	'Diter' is not functioning correctly.	Communication error with cloud control circuit.	(Evolve 200) press the right upper button to reset the alarm power off and power on the machine (evolve 200 plus).	Fault control PC board. Fault cloud connection board.
90	Low gas pressure.	Low gas pressure.	Check the gas supply.	N/A
91	High gas pressure.	High gas pressure.	Check the gas supply.	N/A
92	Low gas flow.	Low gas flow.	Check the gas supply.	N/A
93	High gas flow.	High gas flow.	Check the gas supply.	N/A
100	Exceeding internal voltage limits.	Critical supply voltage in the main control circuit.	Restart the machine. If the problem still exists then contact the service centre.	N/A

TROUBLESHOOTING - ERROR CODES



The following operation requires sufficient professional knowledge on electric aspects and comprehensive safety knowledge. Make sure the input cable of the machine is disconnected from the electricity supply and wait for 5 minutes before removing any machine covers.

The control display is also used for providing error messages to the user, if an error message is displayed, the power source may only function to a limited capacity and the cause of the error should be checked as soon as possible.

The below is a list of error codes for the Jasic Evolve range of welding machines, so some error codes may not be applicable for certain models.

Error Code	Error Meaning	Error Description	Recommended action	Possible Cause
101	CMOS battery failure.	Backup voltage failure.	Restart the machine. If the problem still exists then contact the service centre.	N/A
102	High CPU temperature.	The CPU temperature is too high (80°C).	Restart the machine then wait a few moments until it's cooled down	N/A
103	Error in the UID chipset.	Communication error in the internal circuits.	Restart the machine. If the problem still exists then contact the service centre.	N/A
104	Alarm 24v.	The power supply outside the limits of 24V DC.	Restart the machine. If the problem still exists then contact the service centre.	Overload in the power supply or communication error with the power inverter.
105	Alarm 5v.	The power supply outside the limits of 5V DC.	Restart the machine. If the problem still exists then contact the service centre.	Overload in the power supply or communication error with the power inverter.
106	Alarm -15v.	The power supply outside the limits of -15V DC.	Restart the machine. If the problem still exists then contact the service centre.	Overload in the power supply or communication error with the power inverter.
107	Alarm +15v.	The power supply outside the limits of +15V DC.	Restart the machine. If the problem still exists then contact the service centre.	Overload in the power supply or communication error with the power inverter.
110	Inverter temperature error.	Error in the inverter temperature sensor.	Restart the machine. If the problem still exists then contact the service centre.	N/A
111	P&P temperature error.	Error in the Plug & Play temperature sensor.	Restart the machine. If the problem still exists then contact the service centre.	N/A
112	Short circuit in the NTC 1 sensor.	Short circuit in the inverter temperature sensor.	Restart the machine. If the problem still exists then contact the service centre.	N/A
113	Short circuit in the NTC 2 sensor.	Short circuit in the Plug & Play temperature sensor.	Restart the machine. If the problem still exists then contact the service centre.	N/A
150	Missing water circulation.	Insufficient water in the cooler unit.	Insufficient water in the tank Fault in the water pump. Refill the water tank.	N/A
151	Low water circulation.	Low water flow in the cooler unit.	Insufficient water in the tank Fault in the water pump. Refill the water tank.	N/A
152	High water circulation.	High water flow in the cooler unit.	Fault in the water pump.	N/A
153	Water temperature to high.	High water temperature.	Fault in the water pump.	N/A

TROUBLESHOOTING - ERROR CODES



The following operation requires sufficient professional knowledge on electric aspects and comprehensive safety knowledge. Make sure the input cable of the machine is disconnected from the electricity supply and wait for 5 minutes before removing any machine covers.

The control display is also used for providing error messages to the user, if an error message is displayed, the power source may only function to a limited capacity and the cause of the error should be checked as soon as possible.

The below is a list of error codes for the Jasic Evolve range of welding machines, so some error codes may not be applicable for certain models.

Error Code	Error Meaning	Error Description	Recommended action	Possible Cause
154	High water pump temperature.	Water pump temperature is high.	Restart the machine. If the problem still exists then contact the service centre.	N/A
171	Wire feeder motor encoder error.	Missing feedback from the motor speed sensor.	Restart the machine. If the problem still exists then contact the service centre.	N/A
172	Wire feeder motor speed error.	The wire feeder motor speed is out of the limits.	Wire restriction in the torch. Check the wire exit point.	N/A
173	Wire feeder motor wrong direction alarm.	The wire feeder motor is rotating in the wrong direction.	Check the power cable. Check the encoder connection.	N/A
302	Start-up firmware download fail.	Start-up firmware download fail.	Check if the machine is connected to the internet.	N/A
303	Wrong start-up firmware check.	Start-up firmware verification failed.	Check if the machine is connected to the internet.	N/A
304	Recovery firmware download fail.	Recovery firmware download fail.	Check if the machine is connected to the internet.	N/A
305	Wrong recovery firmware check.	Recovery firmware verification failed.	Check if the machine is connected to the internet.	N/A
306	Machine firmware download fail.	Machine firmware download fail.	Check if the machine is connected to the internet.	N/A
307	Wrong machine firmware check.	Machine firmware verification failed.	Check if the machine is connected to the internet.	N/A
308	Recovery performed.		Restart the machine. If the problem still exists then contact the service centre.	N/A
333	Wi-Fi failure.	Wi-Fi crashed. Machine crashed.	Restart the machine. Restart Wi-Fi and if the problem still exists then contact the service centre.	N/A
334	Flash read only.		Restart the machine. If the problem still exists then contact the service centre.	N/A
335	Internal communication error.	Internal communication error.	Restart the machine. If the problem still exists then contact the service centre.	N/A

WEEE disposal

The equipment is manufactured with materials which do not contain any toxic or poisonous materials dangerous to the operator.

When the equipment is scrapped, it should be dismantled separating components according to the type of materials.

Do not dispose of the equipment with normal waste. The European Directive 2002/96/EC and United Kingdom's Directive The Waste Electrical and Electronic Equipment (WEEE) regulations 2013 states that electrical equipment that has reached its end of life must be collected separately and returned to an environmentally compatible recycling facility.

Jasic has a relevant recycling system which is compliant and registered in the UK with the environment agency. Our registration reference is WEEMM3813AA.

In order to comply with WEEE regulations outside the UK you should contact your supplier.

RoHS Compliance Declaration

We herewith confirm, that the above mentioned product does not contain any of the restricted substances as listed in EU Directive 2011/65/EU and the UK directive ROHS Regulations 2012 in concentrations above the limits as specified therein.

Disclaimer:

Please note that this confirmation is given to the best of our present knowledge and belief.

Nothing herein represents and/or may be interpreted as warranty within the meaning of the applicable warranty law.

EVOLVE 200 - UKCA DECLARATION OF CONFORMITY



UK DECLARATION OF CONFORMITY

The manufacturer or its legal representative Wilkinson Star Limited declares that the equipment listed described below is designed and produced according to the following UK directives:

Electrical equipment (Safety) regulations 2016	2016 No 1101
Electromagnetic compatibility regulations 2016	2016 No 1091
The restriction of the use of certain hazardous substances in electrical and electronic equipment regulations 2012	2012 No 3052
Requirements for welding equipment pursuant to the eco-design for energy related products and energy information regulations 2021	UK SI 2021/745

And inspected in compliance with the following harmonised standards

- BS EN 60974-1:2018 + A1:2019
- BS EN 60974-10:2014 + A1:2015
- BS EN 62822-1:2018
- BS EN 60974-5 2019

Any alteration or change to these machines by any unauthorised person makes this declaration invalid

WILKINSON STAR MODEL
JEV-200PDP

JASIC MODEL
EVOLVE MIG 200P N2D2

Authorised Representative

Wilkinson Star Limited
Shield Drive, Wardley Industrial Estate
Worsley, Salford M28 2WD
Tel +44 161 793 8127

Signature:

Dr John A Wilkinson OBE
Position Chairman
Date: 23/05/2023

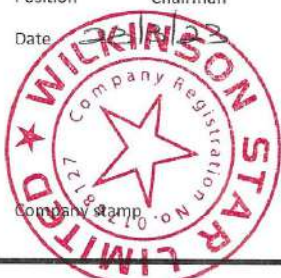

Manufacturer

Shenzhen Jasic Technology Co Ltd
No3 Qinglan, 1st Road
Pingshan District
Shenzhen, China

Signature:

Shenzhen Jasic Technology Co Ltd
Position
Date: 23/05/2023



EVOLVE 200 - EC DECLARATION OF CONFORMITY



EU DECLARATION OF CONFORMITY

The manufacturer or its legal representative Wilkinson Star Limited declares that the equipment listed described below is designed and produced according to the following EU directives:

Low voltage directive (LVD)	2014/35/EU
Electromagnetic compatibility directive (EMC)	2014/30/EU
RoHS2	2011/65/EU
Annex 11 of RoHS2	2015/863
Eco design requirements for welding equipment pursuant 2009/125/EC	2019/1784

And inspected in compliance with the following harmonised standards

- EN 60974-1:2018 + A1:2019
- EN 60974-10:2014 + A1:2015
- EN 62822-1:2018
- EN 60974-5:2019

Any alteration or change to these machines by any unauthorised person makes this declaration invalid

WILKINSON STAR MODEL

JEV-200DP

JASIC MODEL

EVOLVE MIG 200P N2D2

Authorised Representative

Wilkinson Star Limited
Shield Drive, Wardley Industrial Estate
Worsley, Salford M28 2WD
Tel +44 161 793 8127

Signature

Dr John A Wilkinson OBE

Position Chairman

Date 13/12/2021



Company stamp

Manufacturer

Shenzhen Jasic Technology Co Ltd
No3 Qinglan, 1st Road
Pingshan District
Shenzhen, China

Signature

Shenzhen Jasic Technology Co Ltd

Position

Date



Company Stamp

Handwritten signature and date: Mar 24 2022



STATEMENT OF WARRANTY

The JASIC Evolve 200 multi-process welding machine is sold through our partner Wilkinson Star Limited within the United Kingdom and Ireland shall be warranted to the original owner, non transferable, against failure due to defective materials or production.

The warranty period is 5 years following the date of purchase and we recommend that you register your product online within 28 days of purchase at jasic.co.uk.

The original invoice is documentation for the standard warranty period. The warranty period is based on a single shift pattern.

Defective units shall be repaired or replaced by the company at our workshop. The company may opt to refund the purchase price (less any costs and depreciation due to use and wear).

The company reserves the right to alter the warranty conditions at any time with effect for the future.

A prerequisite for the full warranty is that products are operated in accordance with the operating instructions supplied, observing the relevant installation and any legal requirements recommendations and guidelines and carrying out the maintenance instructions shown in the operator manual.

This should always be carried out by a suitably qualified competent person.

Warranty claims will only be accepted from authorised Jasic distributors and in the unlikely event of a problem this should be reported to the technical support team to review the claim.

The customer has no claim to loan or replacement products whilst repairs are being performed.

The following falls outside the scope of the warranty:

- Defects due to natural wear and tear
- Failure to observe the operating and maintenance instructions
- Connection to an incorrect or faulty mains supply
- Overloading during use
- Any modifications that are made to the product without the prior written consent
- Software errors due incorrect operation
- Any repairs that are carried out using non-approved spare parts
- Any transport or storage damage
- Direct or indirect damage as well as any loss of earnings are not covered under the warranty
- External damage such as fire or damage due to natural causes e.g. flooding
- Warranty repairs carried out by non-authorised Jasic distributors.

NOTE: Under the terms of the warranty, welding torches, their consumable parts, wire feed unit drive rolls and guide tubes, work return cables and clamps, electrode holders, connection and extension cables, mains and control leads, plugs, wheels, coolant etc. are covered with a 3 month warranty.

Jasic shall in no event be responsible for any third party expenses or expenses/costs or any indirect or consequential expenses/costs.

Jasic will submit an invoice for any repair work performed outside the scope of the warranty. A quotation for any non warranty will be raised prior to any repairs being carried out.

The decision about repair or replacement of the defective part(s) is made by Jasic. The replaced part(s) remain(s) Jasic property.

Warranty extends only to the machine, its accessories and parts contained inside. No other warranty is expressed or implied. No warranty is expressed or implied in regards to the fitness of the product for any particular application or use.

If in our judgment you fail, or we suspect that you have failed, to comply with any term or provision of the product warranty terms, we reserve the right to deny you access to our services (or any part thereof).

For further information on Jasic product warranty terms and product warranty registration please visit:

www.jasic.co.uk/warranty-information

www.jasic.co.uk/warranty-registration

EVOLVE 200 MACHINE SCHEMATIC

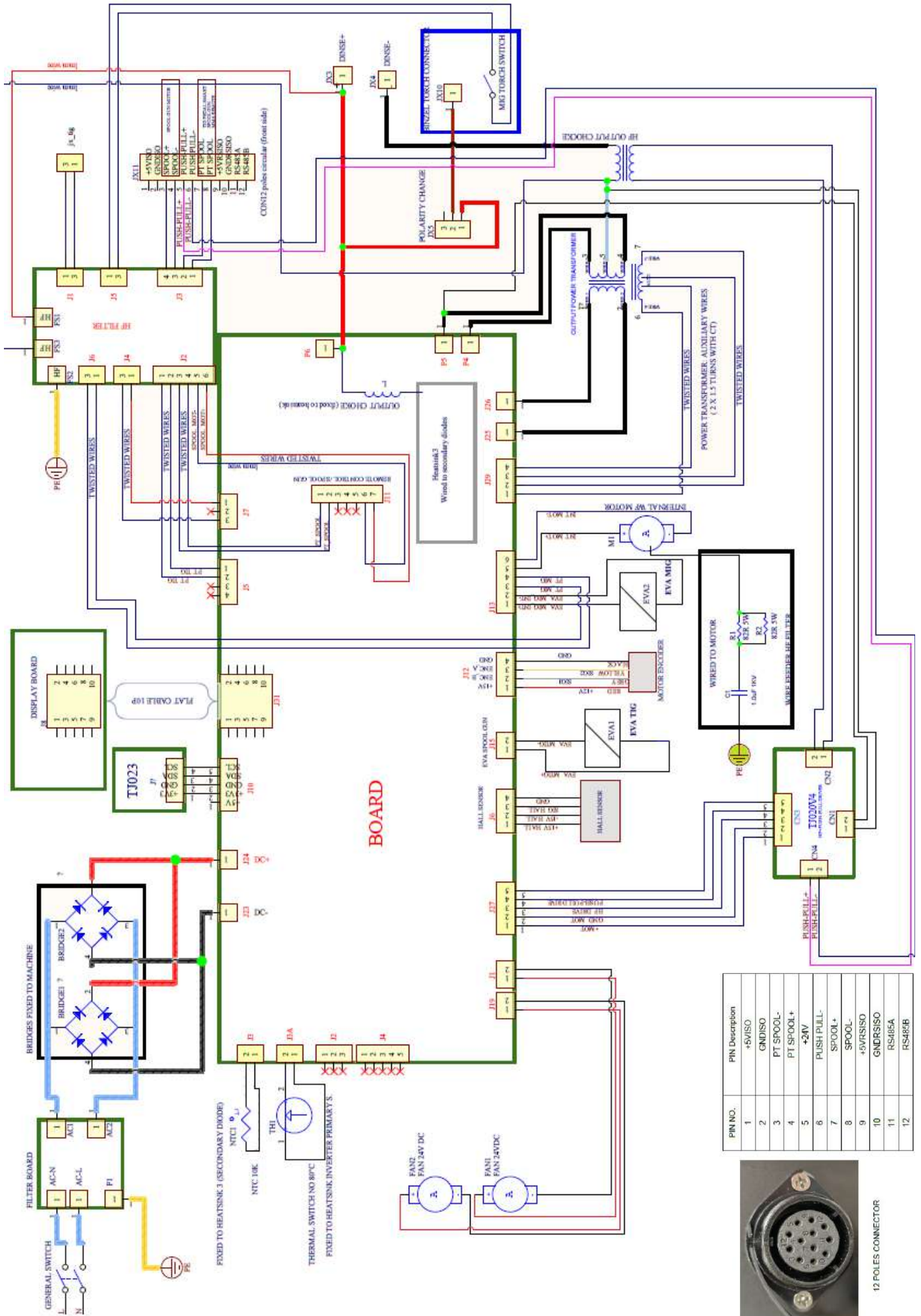

PIN NO.	PIN Description
1	+5VISO
2	GNDISO
3	PT SPOOL-
4	PT SPOOL+
5	+24V
6	PUSH PULL-
7	SPOOL-
8	SPOOL+
9	+5VRSISO
10	GNDRSISO
11	RS485A
12	RS485B



12 POLES CONNECTOR

EVOLVE 200 SYNERGIC PROGRAM TABLE

TIG Synergic program table

Material	Electrode (mm)
Fe	1.6, 2.4
CrNi Stainless Steel (308 - 316)	1.6, 2.4

MIG Synergic program table

Weld Mode	Weld Material	Wire Diameter (mm)	Weld Gas	
Synergic	SG2	0.8	CO2	
		0.9		
		0.8	80/20	
		0.9		
		0.8	92/8	
		0.9		
	SST (CrNi)	0.8	98/2	
		0.9		
	AlMg5	1.2	Argon	
	AlSi5	1.2	Argon	
	Cusi3	0.8	Argon	
	Pulse	SG2	0.8	92/8
0.9				
SST (CrNi)		0.8	92/8	
		0.9		
AlMg5		1.0	Argon	
		1.2		
AlSi5		1.2	Argon	
Cusi3		0.8	Argon	
Twin Pulse		SG2	0.8	92/8
			0.9	
	SST (CrNi)	0.8	92/8	
		0.9		
	AlMg5	1.0	Argon	
		1.2		
	AlSi5	1.2	Argon	
	Cusi3	0.8	Argon	

EVOLVE 200 OPTIONS AND ACCESSORIES

Part Number	Description
HC-300-3E	Hard Core 300A MIG Torch 3mtr Euro *
HC-300-4E	Hard Core 300A MIG Torch 4mtr Euro
HC4BCM	4 Button control module for the Hard Core MIG Torches *
WCS25-3WEL	Welding Cable Set (MMA) 3m
WC-2-03LD	Electrode Holder and lead 3m
EC-2-03LD	Work Return Lead and Clamp 3m *
CP3550	Cable Plug 35-50mm
TSP Evolve	Spool Gun SP250 6m
TIG-110	Titanium 26 TIG Torch 12ft with Single Switch c/w Dinse Adaptor + 2 pin plug *
TIG-110-FLEXI	Titanium 26F TIG Torch 12.5ft c/w Dinse Adaptor + 2 pin plug
TIG-110-8M	Titanium 26 TIG Torch 25ft c/w Dinse Adaptor + 2 pin plug
TIG-110-8M-FLEXI	Titanium 26F TIG Torch 12.5ft c/w Dinse Adaptor + 2 pin plug
JH-HDX	Jasic HD True Colour Auto Darkening Welding Helmet
JFC-EVOLVE	Wired foot pedal remote current control
JG07008-1	2 Pin control plug
JM-12PP	12 pin control plug
Drive rolls for the Evolve 200 (4 roll drive) ***	
10055168	Feed Roller 0.6mm/0.8mm "V" Groove
10036428	Feed Roller 0.8mm/1.0mm "V" Groove
10039481	Feed Roller 1.0mm/1.2mm "V" Groove **
10029314	Feed Roller 1.2mm/1.6mm "V" Groove
10029899	Feed Roller 0.8mm/1.0mm "U" Groove
10016532	Feed Roller 1.0mm/1.2mm "U" Groove *
10029904	Feed Roller 1.0mm/1.6mm FCW

* Items supplied as standard with a new machine package

** Factory fitted roller

Please Note:

*** Drive rolls are supplied and sold in quantities of 1



Wilkinson Star Limited

Shield Drive
Wardley Industrial Estate
Worsley
Manchester
UK
M28 2WD

+44(0)161 793 8127



| **Passionate About Your Welding**

www.jasic.co.uk

August 2024 Issue 1